

ASANSÖR GÜVENLİK EKİPMANLARI

www.erkanelift.com.tr



EAC

CE

2528



ERKAN
ALÜMİNYUM ASANSÖR İNŞAAT
DIŞ TİC. SAN. & TİC. LTD. ŞTİ. **LIFT**

Erkan Torna'nın temelleri 2001 yılında Konya'da küçük bir torna atölyesinde faaliyetine başlamıştır. Firmamız 2006 yılında bugünkü bulunduğu noktada, Erkan Torna ismini Erkan Lift olarak değiştirerek Firma bünyesinde başlangıçta yurtiçi asansör firmalarının ihtiyaç duyduğu asansör yedek parça elemanlarının imalatını yapmıştır. 2006 yılından itibaren Kurumsallaşma ve Gelişim sürecine giren firma, ihracata başlamıştır.

Erkan Lift olarak 2100 m2 kapalı 8200m2 açık alanda, asansör emniyet ekipmanları ve alüminyum küpeşte üretimini gerçekleştirmektedir.

Konusunda uzman bir yönetim ve üretim anlayışı sergileyen Erkan Lift günün koşullarına uygun tesisinde kaliteye her zaman büyük önem vermiştir. ISO 9001 kalite sistemine uygun çalışmakta olan firmamız küresel bir firma olma yolunda hızla ilerlemektedir.

Pazar tecrübesi ile oluşan güven, iş ahlakı ve çalışma azminin yanı sıra günün teknolojilerine uygun yatırımları ile Erkan Lift şık ve estetik mekanlara kaliteli ve modern ürünler üretmektedir.

ZİRVEDEKİ

Emniyetiniz



Erkan lathe was founded in 2001 in Konya in a small Lathe workshop. In 2006 Erkan lathe changed its name to Erkan lift and we became one of the suppliers which is producing elevator equipment and spare parts in the domestic market to the local elevator producers. After 2006 with development of the company and the start of institutionalization the company also start to serve to the international markets.

As Erkan lift we are operating in space of 1800 m2 closed and 8200 m2 open area, and we are producing elevator safety equipment and Aluminium hand rails.

As Erkan lift we always are giving a huge importance to product quality and quality management, due to this reason we are operating according to the ISO 9001 quality management system. This understanding took us foward and we are becoming a global player role in the international market.

With our market experiance, continous technology investment, working ethics and work ambition we establish a trust against our brand and we are producing quality, modern and aesthetic products.

من نحن

في عام

الموقع الحالي مقرها، وبدأت بتصنيع قطع غيار المصاعد للأسواق المحلية.

منذ عام 2007 دخلت عملية التطوير وإضفاء الطابع المؤسسي على الشركة وبدأنا بالتصدير الى الأسواق العالمية.

مصاعد إركان ليفت ، تقوم بتصنيع معدات سلامة المصاعد ومقابض الألمنيوم للكبائن في مساحة مغلقة 1800 متر مربع و8200 متر مربع إجمالي مساحة المصنع لطالما أولت إركان ليفت ، أهمية كبيرة للجودة المنتجات واعتماد رضا العملاء كمبدأ لذلك أظهرنا نهجًا إداريًا متخصصًا من خلال فريق الانتاج ذو خبرة عالية يعمل

على الانتاج وفق معايير ونظام الجودة العالمي ايزو 9001.

تنتج إركان ليفت منتجات عالية الجودة مطابقة للمعايير الدولية وعصرية مناسبة للأماكن ذات الطابع الجمالي من خلال استخدامها أحدث التقنيات، وخبرة وتجارب السنوات السابقة.

ZİRVEDEKİ

Emniyetiniz

KALİTE

Erkan Lift, ürünlerine CE ve EAC belgeleri olarak sürekli iyileştirme kültürü ile paydaşlarının değişen beklenti ve gereksinimlerini birlikte ele alan bir vizyon ve yaklaşım ile tüm ürün ve proseslerini tasarlar, uygular ve sürekli geliştirir.

Şirket; vizyon ve uzun dönemli hedefleriyle uyumlu olarak, her aşamada üst yönetim desteğini ve tüm çalışanların kalite bilinç ve kültürü ile katılımını sağlayarak, yüksek kalite standartlarında global rekabetçi ve yenilikçi ürünler üretmektedir.

Erkan Lift'in sunmuş olduğu asansör emniyet ekipmanları, yüksek verimlilik ve performansı ile asansörler koruma altındadır.

QUALITY

Erkan lift has certified its products with CE and EAC certifications and we are always in a continues development of our product and quality process. As a company vision and with the support of our upper-management we are applying our quality understanding with our labour and we are producing to global quality standards.

With Erkan lifts highly efficient and performance products, which are served to the markets are taking your elevators under our safety.

الجودة

تصمم إركان ليفت جميع منتجاتها بكافة مراحل الانتاج بما يتوافق مع شهادات سي اي وإي أي سي، وتعمل على تحسينها مع ثقافة التطوير المستمر والتوقعات والاحتياجات المتغيرة للأسواق العالمية
تماشيًا مع رؤيتنا وأهدافنا طويلة المدى، فإننا ننتج منتجات تنافسية ومبتكرة عالميًا بمعايير جودة عالية من خلال توفير دعم الإدارة العليا في كل مرحلة من مراحل الانتاج ومشاركة جميع الموظفين بوعي وثقافة الجودة
معدات السلامة المصاعد التي تنتجها إركان ليفت تعطي للمصعد كفاءة وحماية عالية

ASANSÖR GÜVENLİK EKİPMANLARI

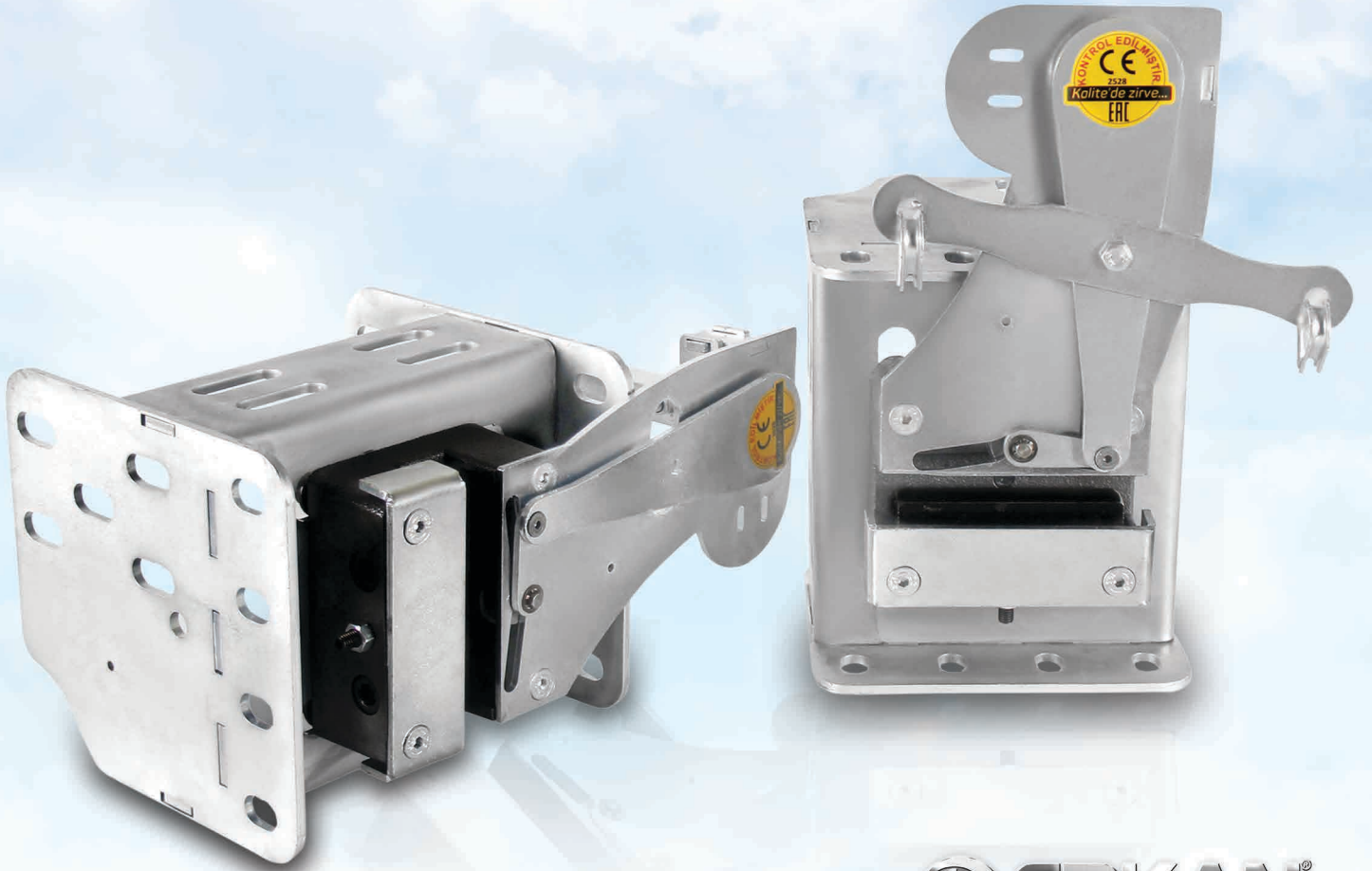
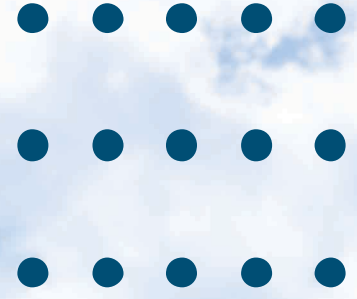

ÖZEL AĞIRLIK
ŞASE FRENİ

COUNTER WEIGHT
BRAKE

فرامل الثقال

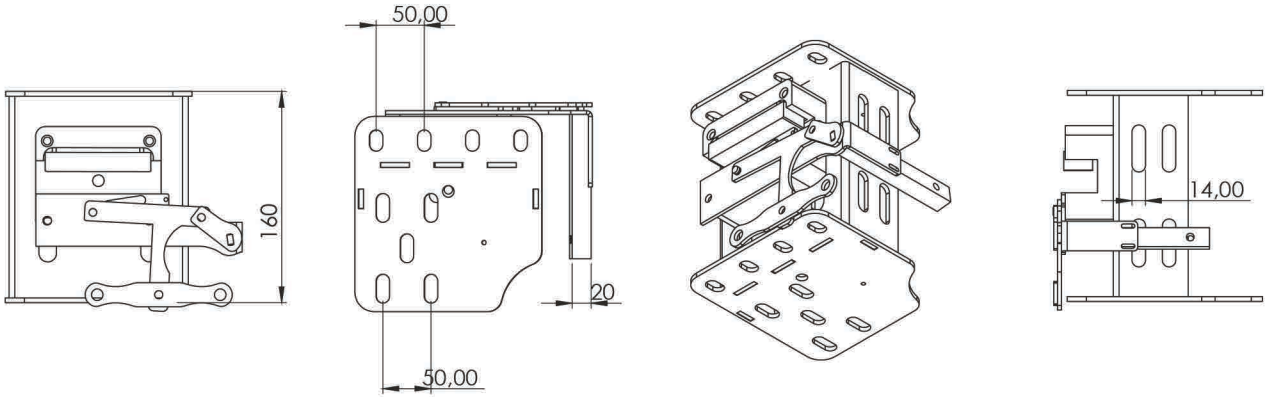
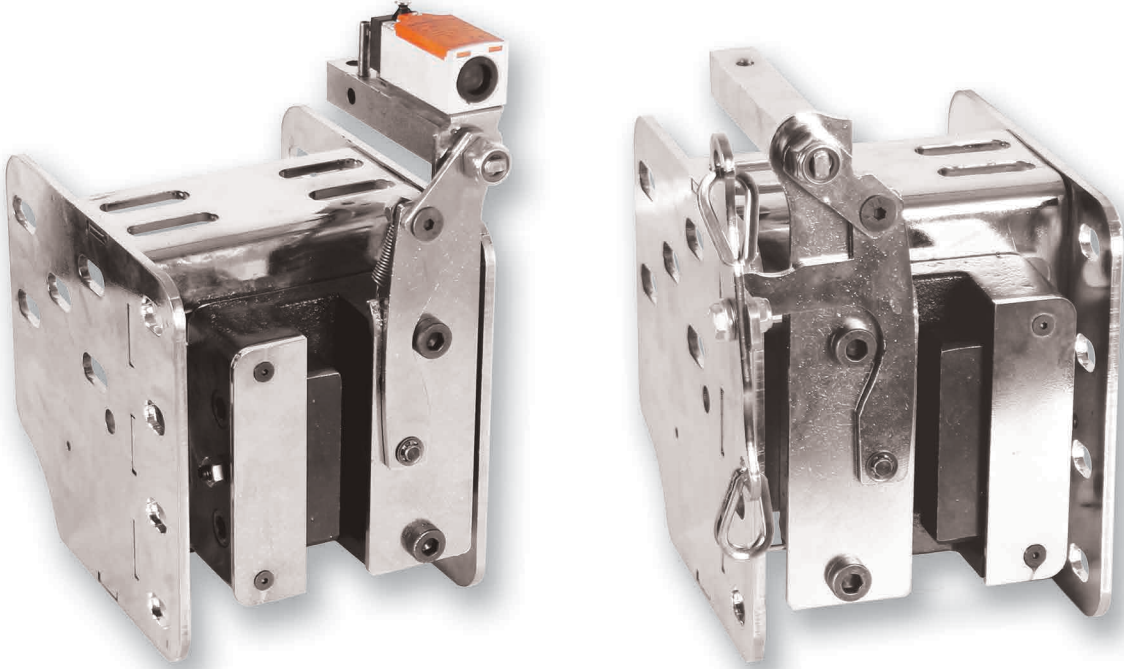

ÜRÜN KOD Product Code كود المنتج

EL7 I-9 MM

ÖZEL AĞIRLIK ŞASE FRENİ Counter Weight Brake فرامل الثقال

ÇALIŞMA HIZI Working Speed 1 M/SN
P+Q 700/2400 KG
ÇALIŞMA HIZI Working Speed 1,6 M/SN
P+Q 700/2000 KG



www.erkanlift.com.tr

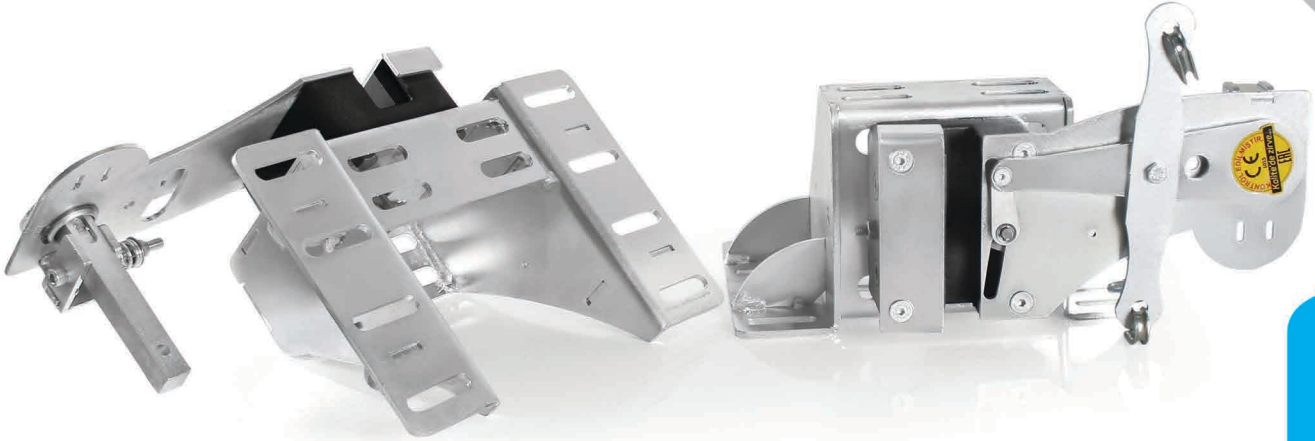

REVİZYON EMNİYET
TERTİBATI 9 MM

REVISION SAFETY
GEAR 9 MM

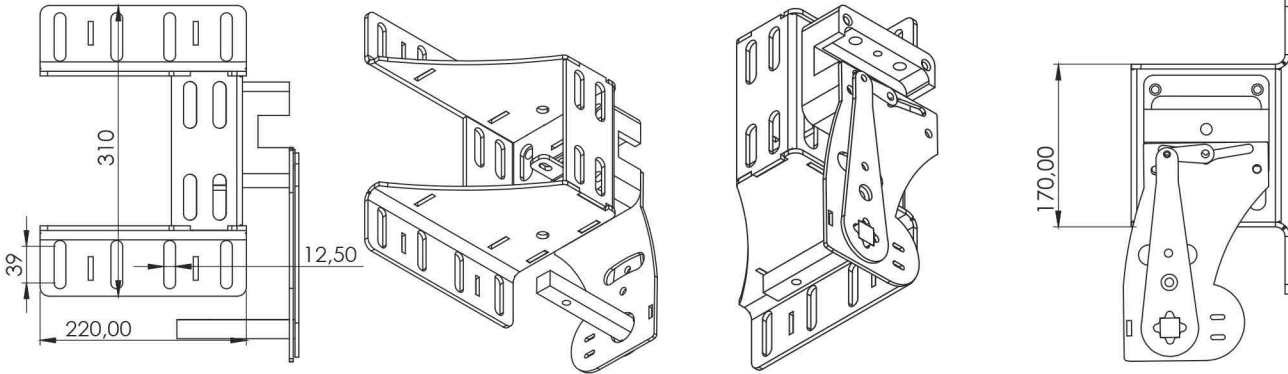

فرامل ذو اتجاهین
ریفزیون 9 ملم

ÜRÜN KOD Product Code كود المنتج

EL7-9 MM

REVİZYON EMNİYET TERTİBATI Revision Safety Gear فرامل ذو اتجاهین ریفزیون

ÇALIŞMA HIZI Working Speed 1 M/SN
P+Q 700/2400 KG
ÇALIŞMA HIZI Working Speed 1,6 M/SN
P+Q 700/2000 KG



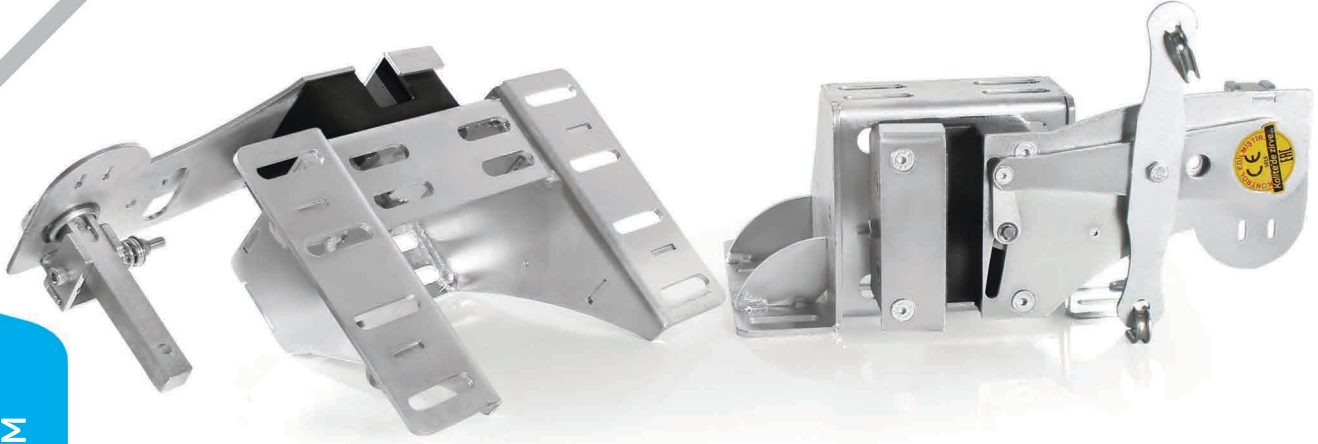

REVİZYON EMNİYET
TERTİBATI 16 MM

REVISION SAFETY
GEAR 16 MM

فرامل ذو اتجاهین
ریفزیون 16ملم

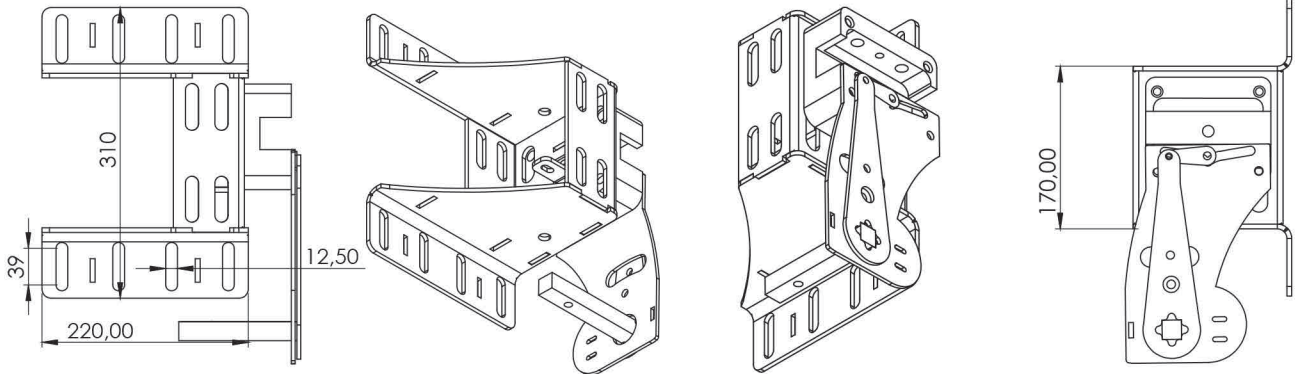

ÜRÜN KOD Product Code كود المنتج

EL8-16MM

REVİZYON EMNİYET TERTİBATI Revision Safety Gear فرامل ذو اتجاهین ریفزیون

ÇALIŞMA HIZI Working Speed 1 M/SN

P+Q 700/2700 KG

ÇALIŞMA HIZI Working Speed 1,6 M/SN

P+Q 700/2000 KG



www.erkanelift.com.tr

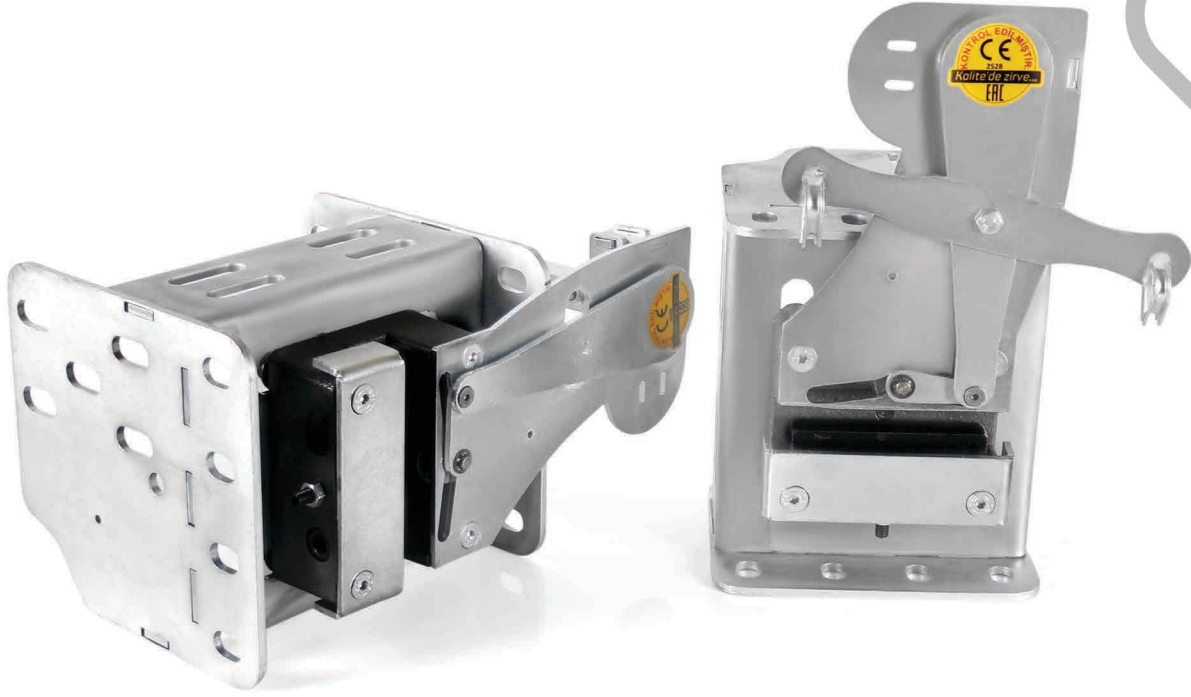

KAYMALI FREN
9 MM

GLIDING SAFETY
GEAR 9MM

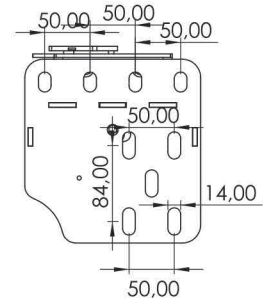
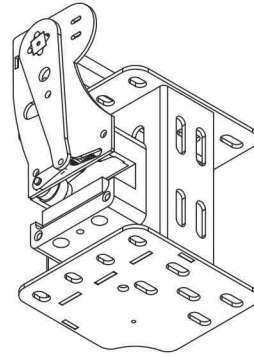
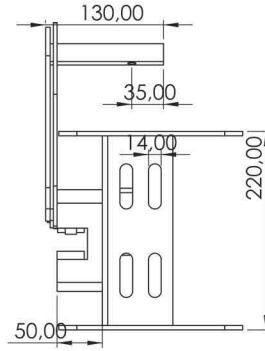
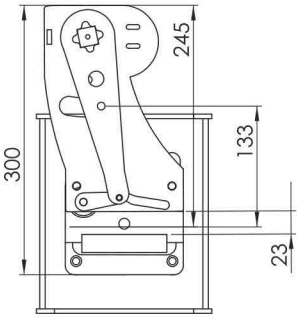

ÜRÜN KOD Product Code كود المنتج

EL5-9 mm (Çift Yön) Bidirectional
EL5-9 l mm (Tek Yön) Single directional

اتجاهين
اتجاه واحد

KAYMALI FREN EMNİYET TERTİBATI

Gliding Safety Gear

فرامل انزلاق

ÇALIŞMA HIZI Working Speed 1.0 M/SN
P+Q 700/2400 KG
ÇALIŞMA HIZI Working Speed 1.6 M/SN
P+Q 700/2000 KG

فرامل انزلاق
9 ملر

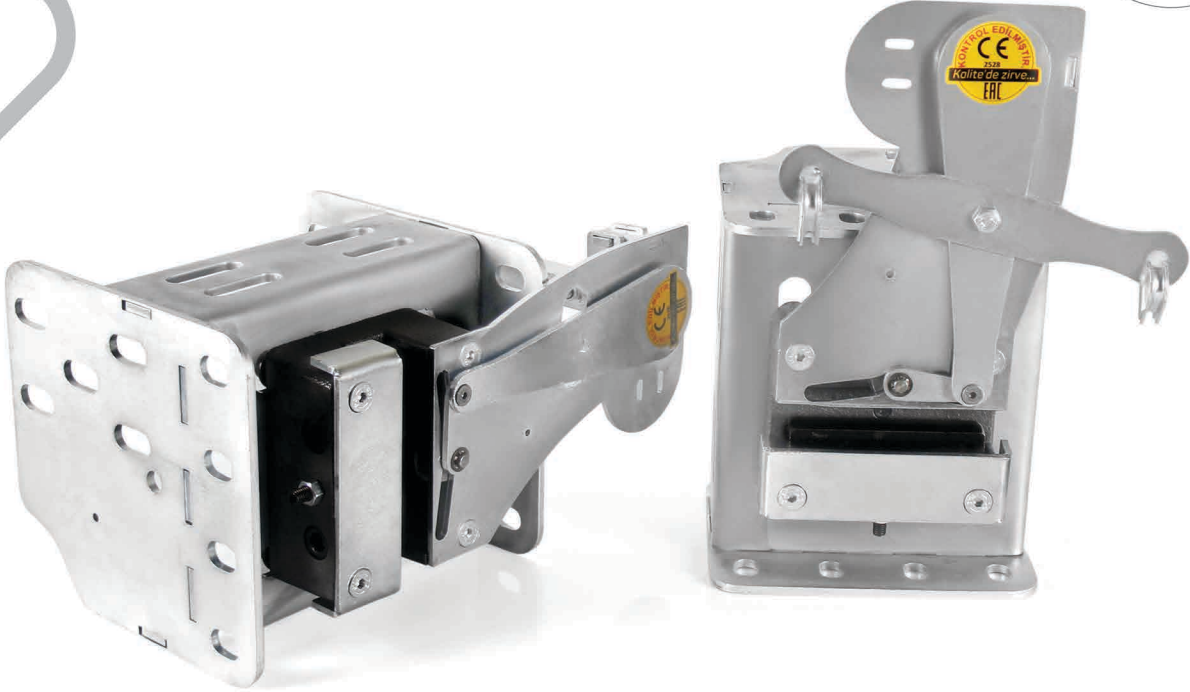

KAYMALI FREN

GLIDING SAFETY
GEAR

فرامل انزلاق

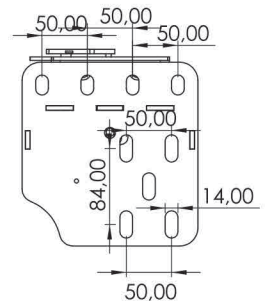
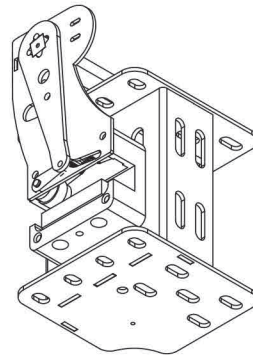
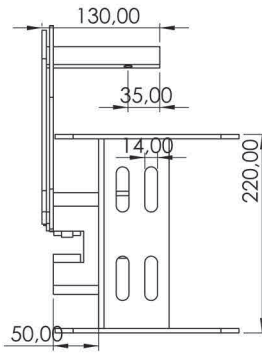
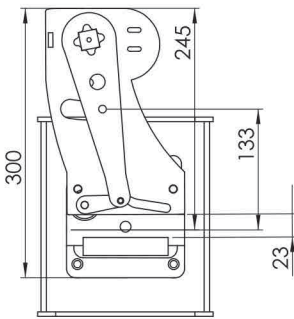

ÜRÜN KOD Product Code كود المنتج

EL6-9/16 mm (Çift Yön) Bidirectional
EL6-9I/16 mm (Tek Yön) Single directional

Bidirectional
Single directional

اتجاهين
اتجاه واحد

KAYMALI FREN EMNİYET TERTİBATI

Gliding Safety Gear

فرامل انزلاق

P+Q 800/2700KG

HIZ Speed 1,0 M/SN



www.erkanlift.com.tr

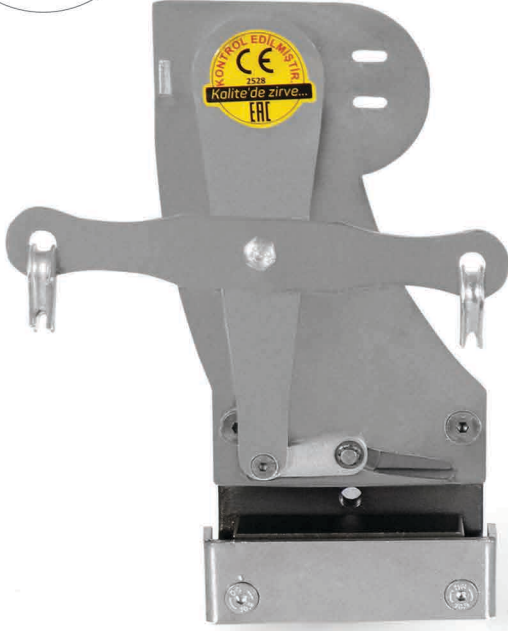

L KARKAS
KAYMALI FREN

CARACASS
SAFETY GEAR

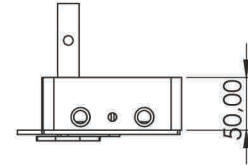
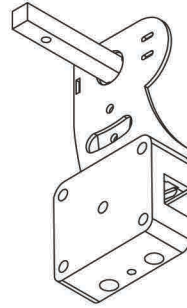
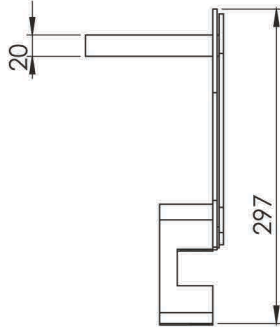
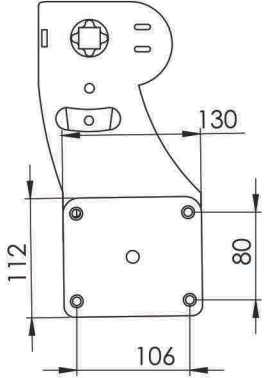

ÜRÜN KOD Product Code كود المنتج

EL6-9/16 mm (Çift Yön) Bidirectional
EL6I -9/16 mm (Tek Yön) Single directional

اتجاهين
اتجاه واحد

L KARKAS KAYMALI FREN EMNİYET TERTİBATI Caracass Safety Gear فرامل انزلاق بدون قاعدة

P+Q 800/2700 KG
HIZ Speed 1.00 M/SN

فرامل انزلاق
بدون قاعدة

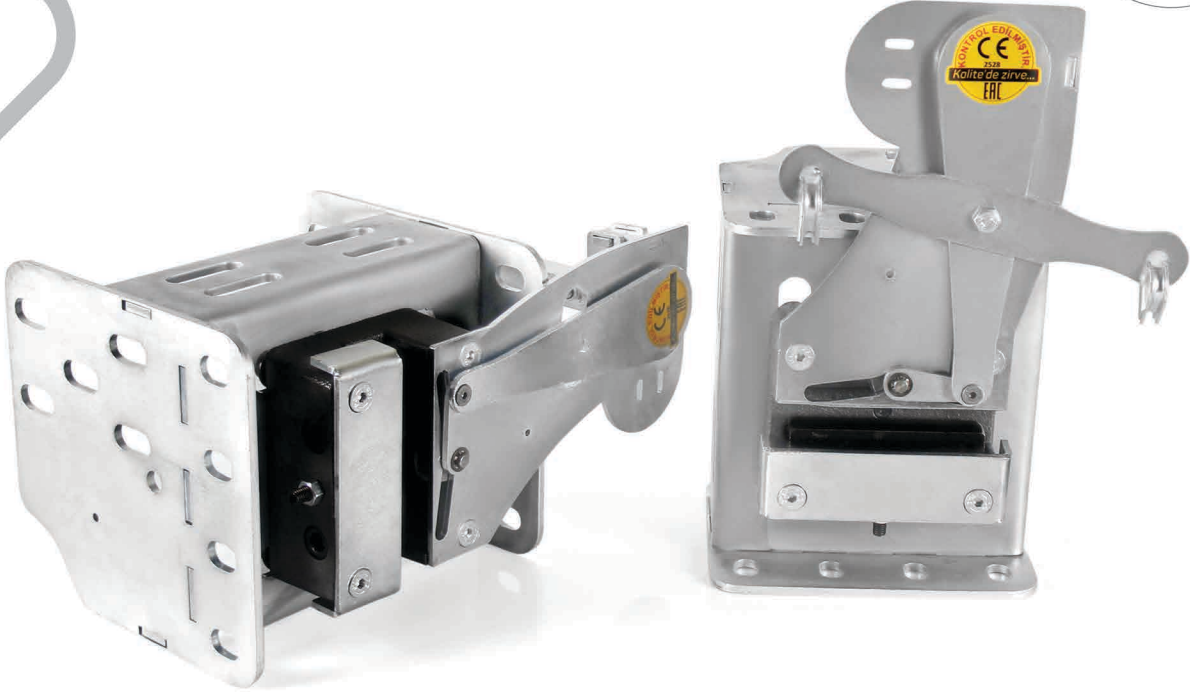

KAYMALI FREN

GLIDING SAFETY
GEAR

فرامل انزلاق

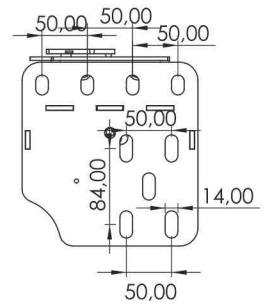
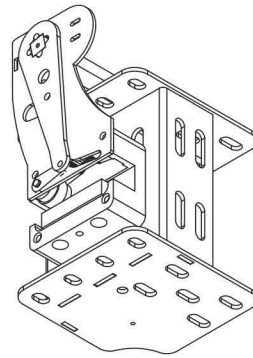
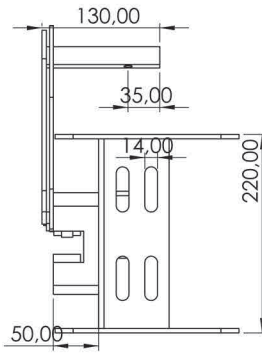
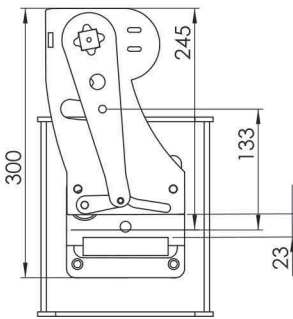

ÜRÜN KOD Product Code كود المنتج

EL6-9/16 mm (Çift Yön) Bidirectional

اتجاهين

EL6 I -9/16 mm (Tek Yön) Single directional

اتجاه واحد

KAYMALI FREN EMNİYET TERTİBATI

Gliding Safety Gear

فرامل انزلاق

P+Q 800/2000 KG
HIZ Speed 1.60 M/SN



www.erkanlift.com.tr

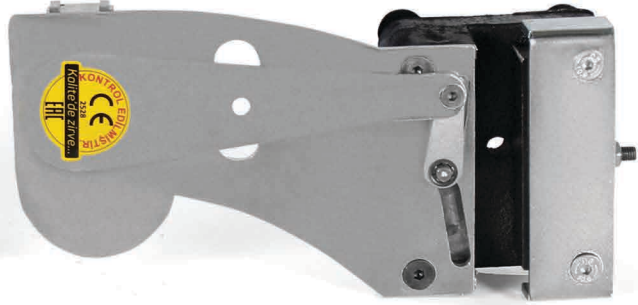

L KARKAS
KAYMALI FREN

CARACASS
SAFETY GEAR

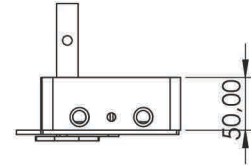
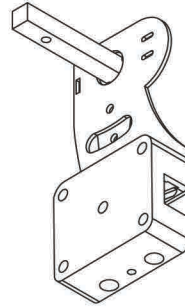
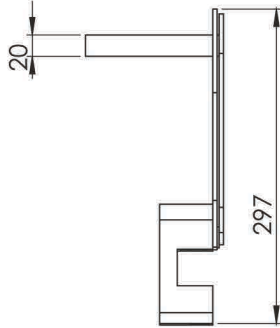
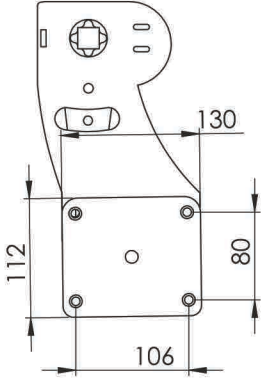

ÜRÜN KOD Product Code كود المنتج

EL6-9/16 mm (Çift Yön) Bidirectional
EL6 I-9/16 mm (Tek Yön) Single directional

اتجاهين
اتجاه واحد

L KARKAS KAYMALI FREN EMNİYET TERTİBATI Caracass Safety Gear فرامل انزلاق بدون قاعدة

P+Q 800/2000 KG
HIZ Speed 1.60 M/SN

فرامل انزلاق
بدون قاعدة



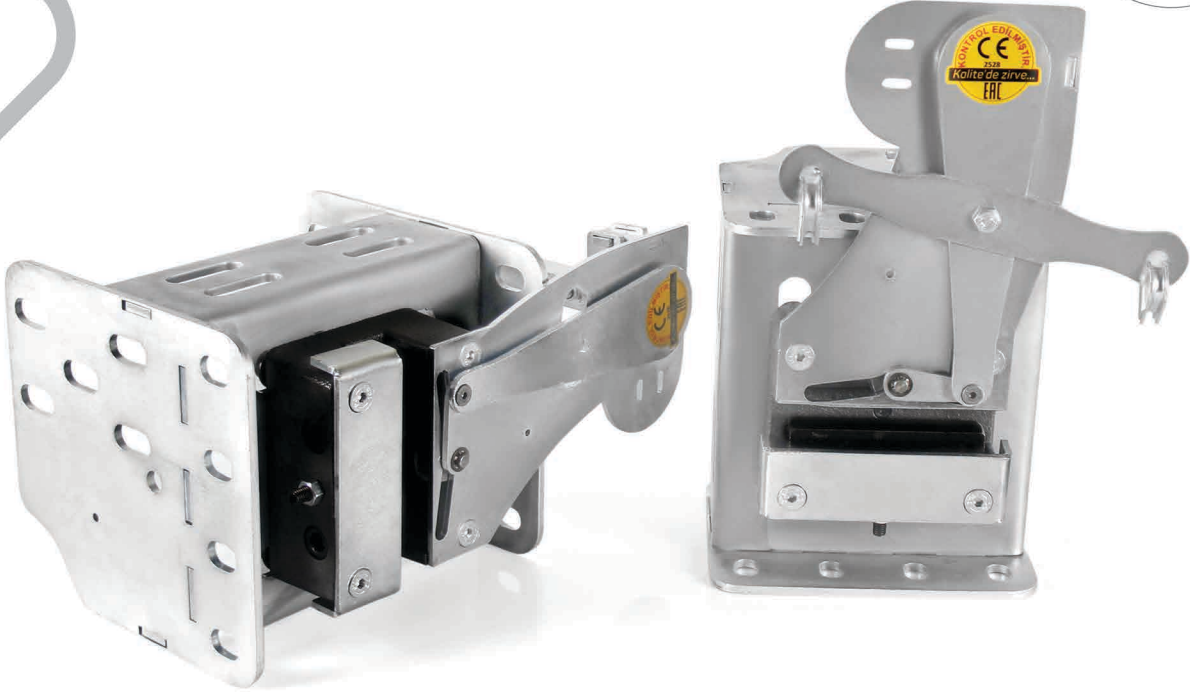

KAYMALI FREN

GLIDING SAFETY
GEAR

فرامل انزلاق

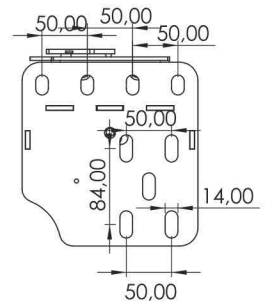
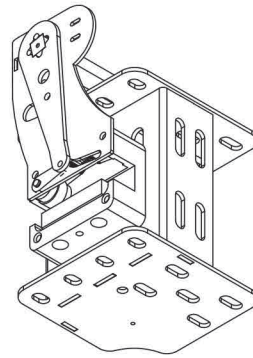
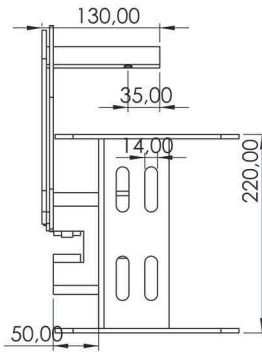
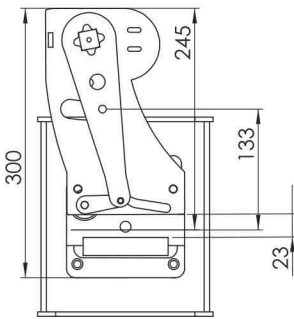

ÜRÜN KOD Product Code كود المنتج

EL6-9/16 mm (Çift Yön) Bidirectional
EL6 I-9/16 mm (Tek Yön) Single directional

اتجاهين
اتجاه واحد

KAYMALI FREN EMNİYET TERTİBATI

Gliding Safety Gear

فرامل انزلاق

P+Q 800/3000 KG
HIZ Speed 1.60 M/SN



www.erkanlift.com.tr

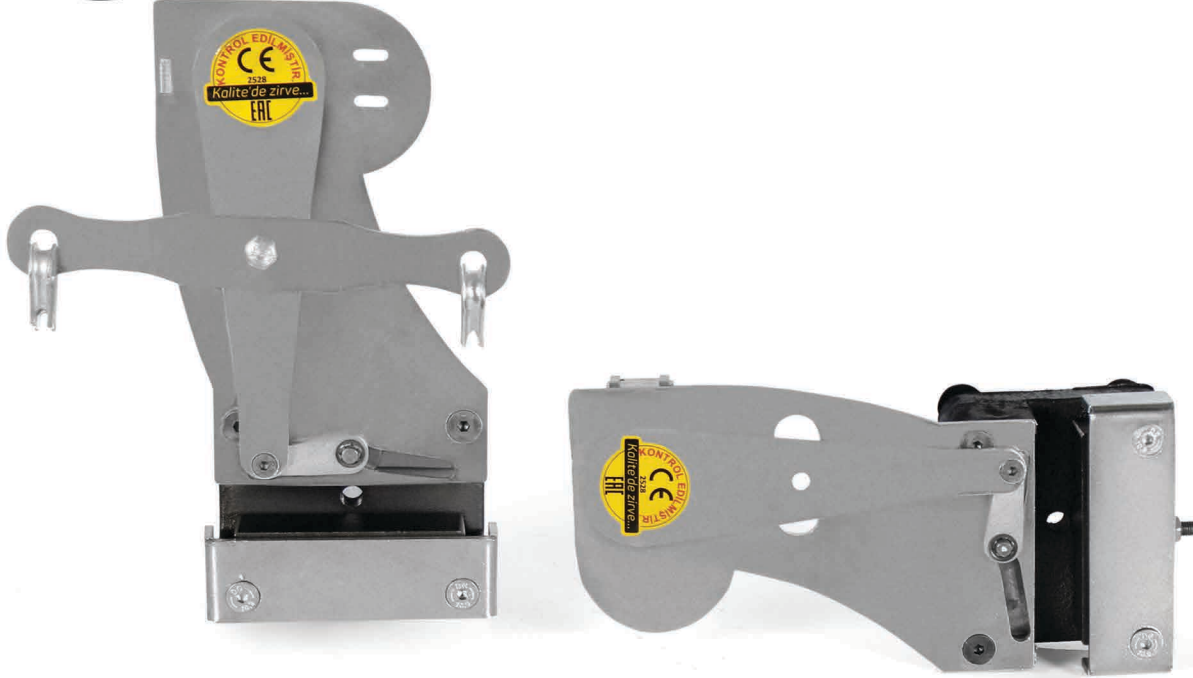

L KARKAS
KAYMALI FREN

CARACASS
SAFETY GEAR

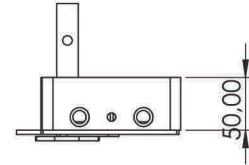
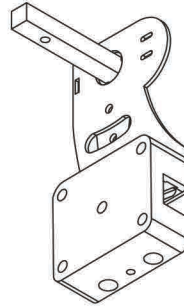
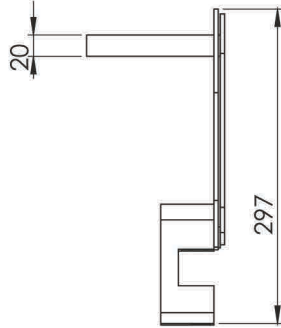
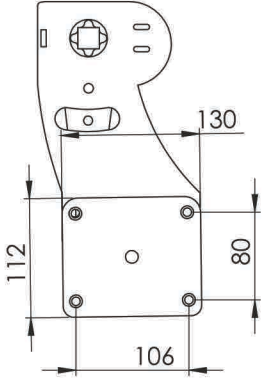

ÜRÜN KOD Product Code كود المنتج

EL6-9/16 mm (Çift Yön) Bidirectional اتجاهين
EL6-9 I /16 mm (Tek Yön) Single directional اتجاه واحد

L KARKAS KAYMALI FREN EMNİYET TERTİBATI Caracass Safety Gear فرامل انزلاق بدون قاعدة

P+Q 800/3000 KG
HIZ Speed 1.60 M/SN

فرامل انزلاق
بدون قاعدة



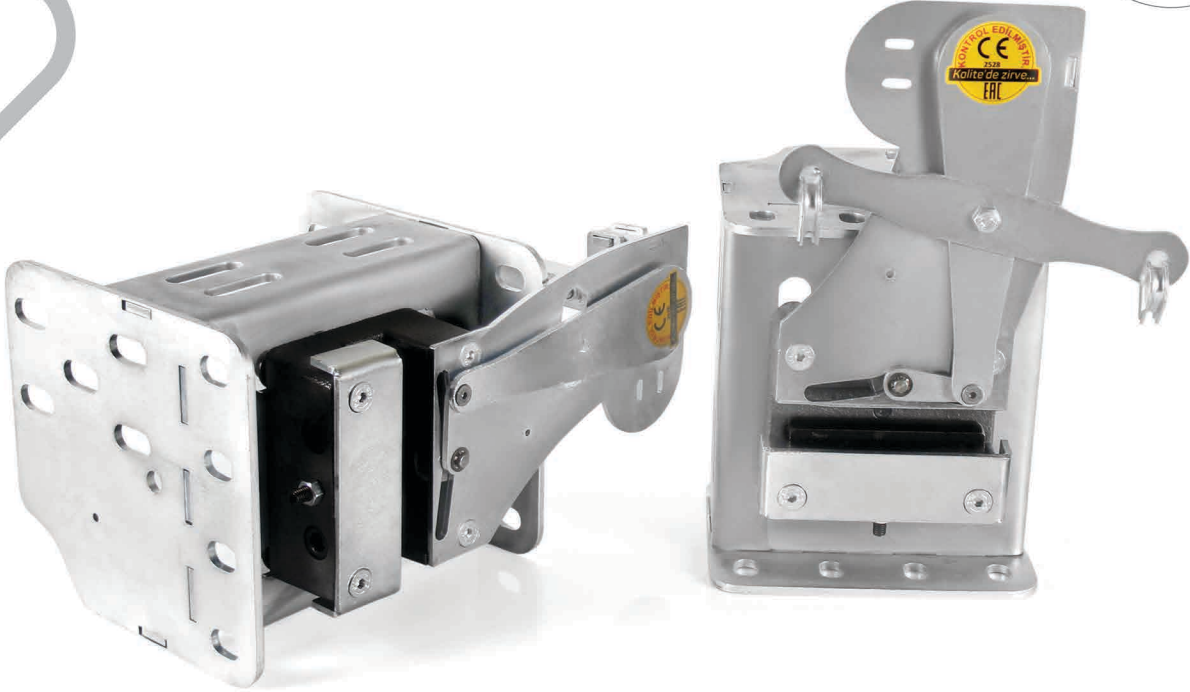

KAYMALI FREN

GLIDING SAFETY
GEAR

فرامل انزلاق

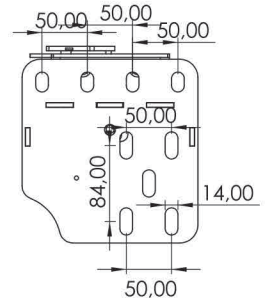
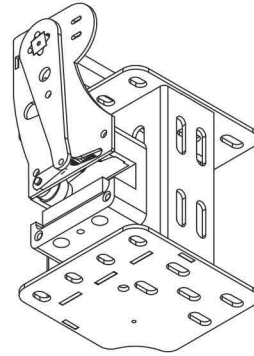
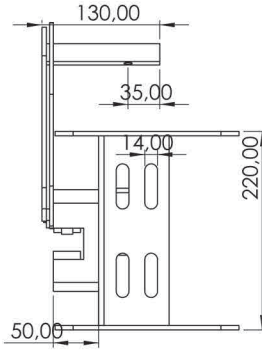
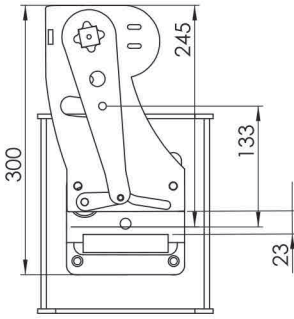

ÜRÜN KOD Product Code كود المنتج

EL6-9/16 mm (Çift Yön) Bidirectional
EL6-9 I/16 mm (Tek Yön) Single directional

اتجاهين
اتجاه واحد

KAYMALI FREN EMNİYET TERTİBATI

Gliding Safety Gear

فرامل انزلاق

P+Q 800/2300 KG
HIZ Speed 2.00 M/SN



www.erkanlift.com.tr

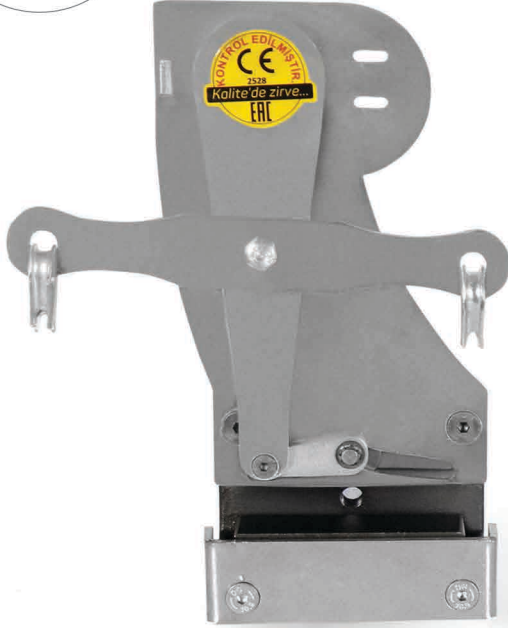

L KARKAS
KAYMALI FREN

CARACASS
SAFETY GEAR

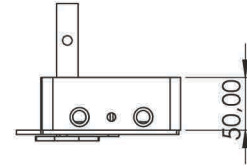
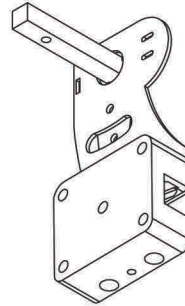
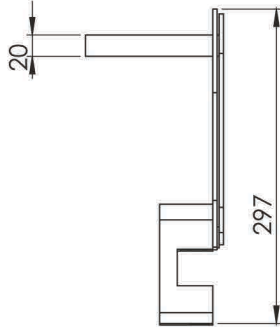
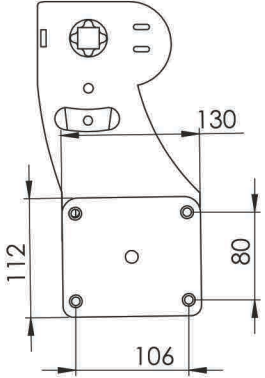

ÜRÜN KOD Product Code كود المنتج

EL6-9/16 mm (Çift Yön) Bidirectional
EL6-91/16 mm (Tek Yön) Single directional

اتجاهين
اتجاه واحد

L KARKAS KAYMALI FREN EMNİYET TERTİBATI Caracass Safety Gear فرامل انزلاق بدون قاعدة

P+Q 800/2300 KG
HIZ Speed 2.00 M/SN

فرامل انزلاق
بدون قاعدة



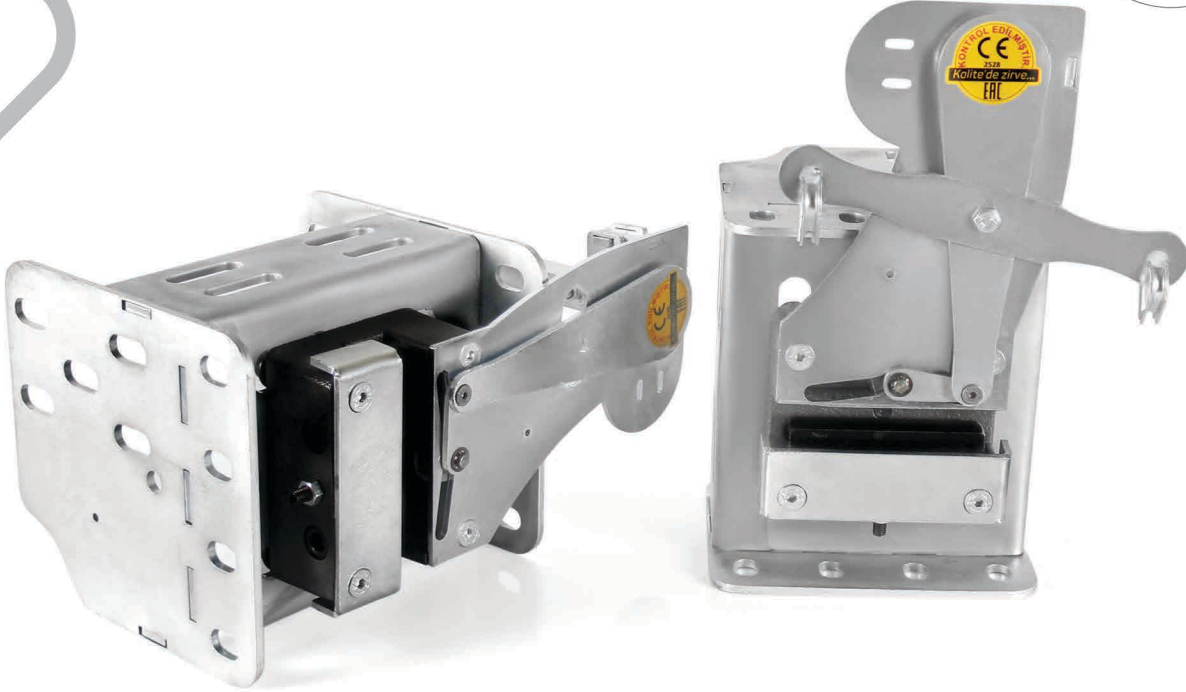

KAYMALI FREN

GLIDING SAFETY
GEAR

فرامل انزلاق

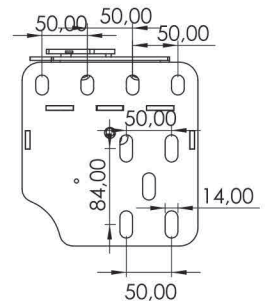
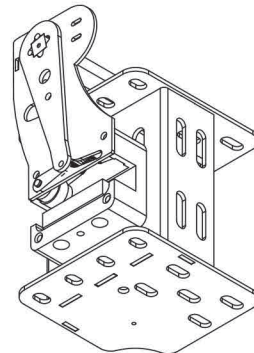
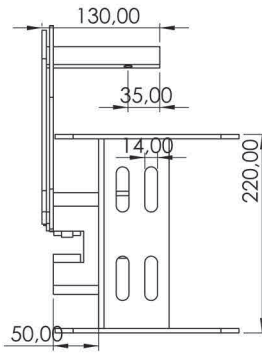
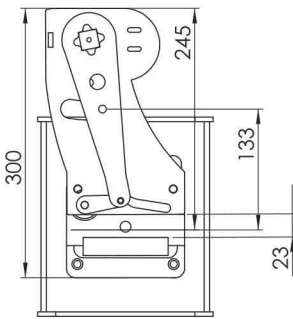

ÜRÜN KOD Product Code كود المنتج

EL7-9 mm (Çift Yön)
EL7-9 I mm (Tek Yön)

Bidirectional
Single directional

اتجاهین
اتجاه واحد

KAYMALI FREN EMNİYET TERTİBATI

Gliding Safety Gear

فرامل انزلاق

ÇALIŞMA HIZI Working Speed 1.0 M/SN
P+Q 700/2400 KG
ÇALIŞMA HIZI Working Speed 1.6 M/SN
P+Q 700/2000 KG



www.erkanlift.com.tr

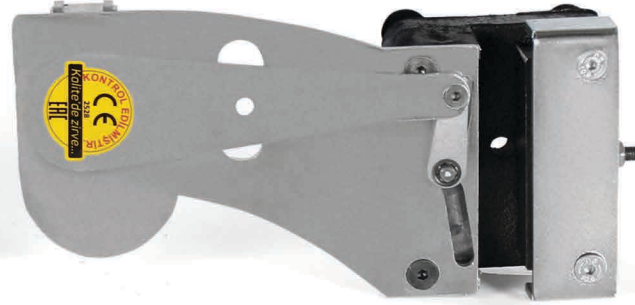

L KARKAS
KAYMALI FREN

CARACASS
SAFETY GEAR

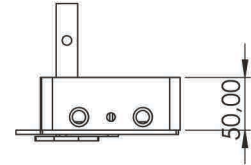
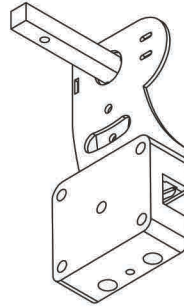
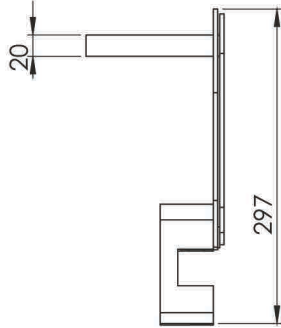
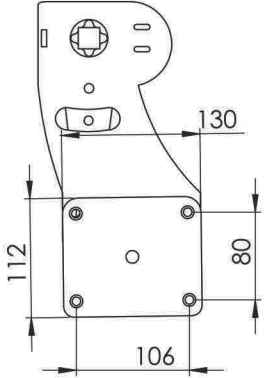

ÜRÜN KOD Product Code كود المنتج

EL7-9 mm (Çift Yön)
EL7-9 I mm (Tek Yön)

Bidirectional
Single directional

اتجاهين
اتجاه واحد

L KARKAS KAYMALI FREN EMNİYET TERTİBATI Caracass Safety Gear فرامل انزلاق بدون قاعدة

ÇALIŞMA HIZI Working Speed 1.0 M/SN
P+Q 700/2400 KG
ÇALIŞMA HIZI Working Speed 1.6 M/SN
P+Q 700/2000 KG

فرامل انزلاق
بدون قاعدة



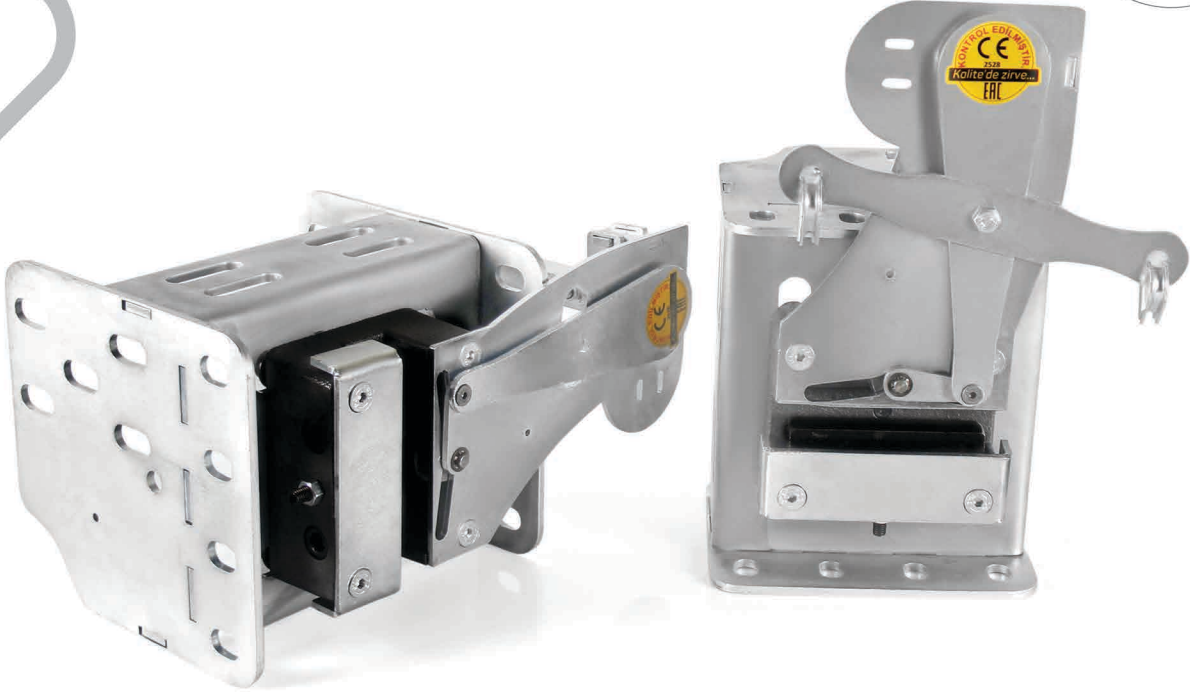

KAYMALI FREN

GLIDING SAFETY
GEAR

فرامل انزلاق

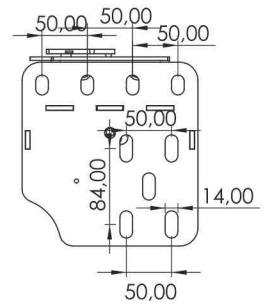
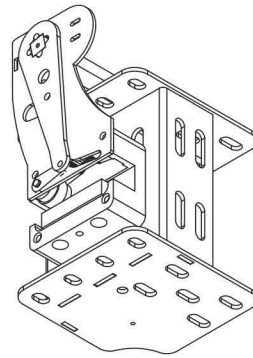
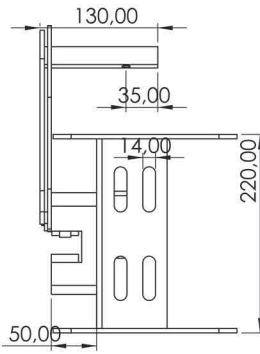
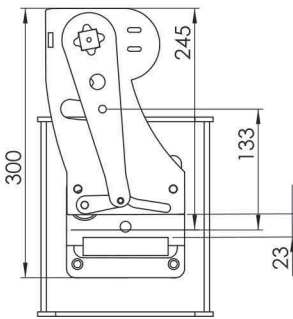

ÜRÜN KOD Product Code كود المنتج

EL8-16 mm (Çift Yön)
EL8 I-16 mm (Tek Yön)

Bidirectional
Single directional

اتجاهین
اتجاه واحد

KAYMALI FREN EMNİYET TERTİBATI

Gliding Safety Gear

فرامل انزلاق

ÇALIŞMA HIZI Working Speed 1.0 M/SN
P+Q 800/2700 KG
ÇALIŞMA HIZI Working Speed 1.6 M/SN
P+Q 700/2000 KG



www.erkanelift.com.tr

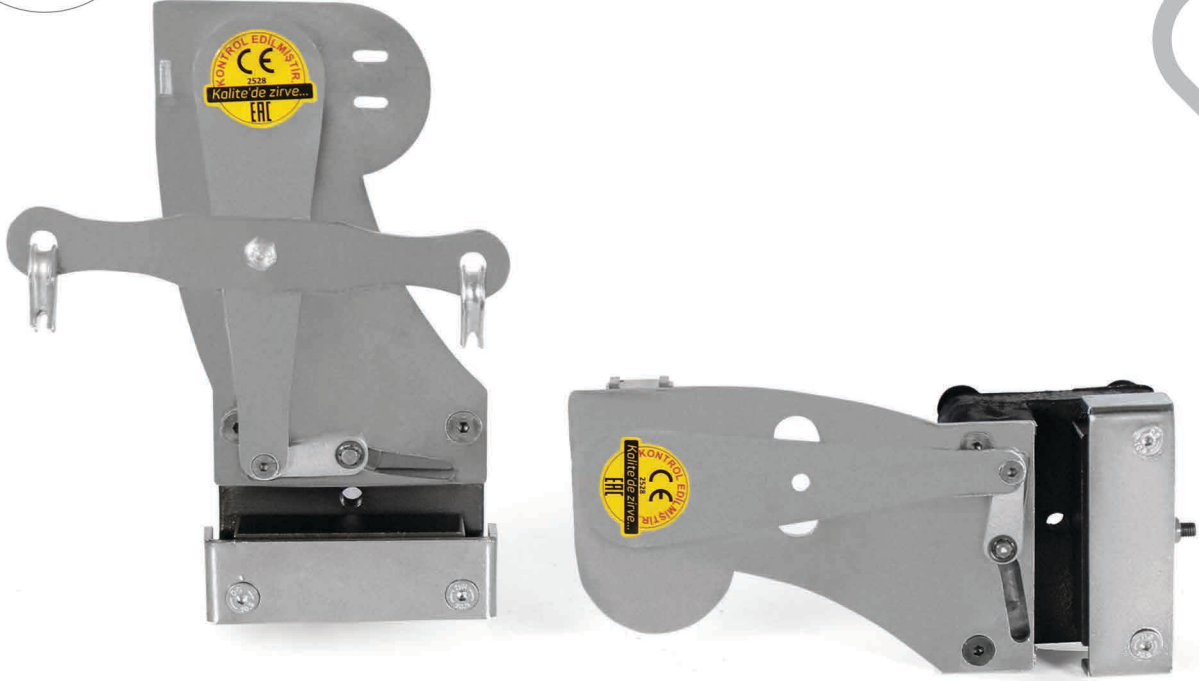

L KARKAS
KAYMALI FREN

CARACASS
SAFETY GEAR

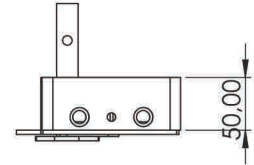
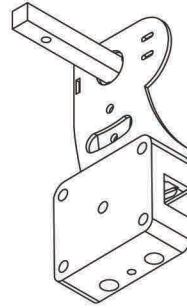
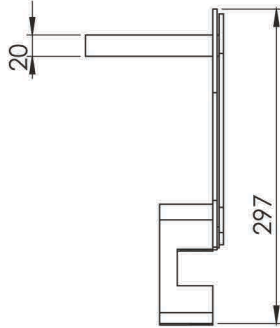
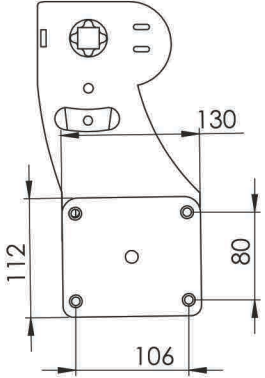

ÜRÜN KOD Product Code كود المنتج

EL8-16 mm (Çift Yön) Bidirectional
EL8 I -16 mm (Tek Yön) Single directional

اتجاهين
اتجاه واحد

L KARKAS KAYMALI FREN EMNİYET TERTİBATI Caracass Safety Gear فرامل انزلاق بدون قاعدة

ÇALIŞMA HIZI Working Speed 1.0 M/SN
P+Q 800/2700 KG
ÇALIŞMA HIZI Working Speed 1.6 M/SN
P+Q 700/2000 KG

فرامل انزلاق
بدون قاعدة

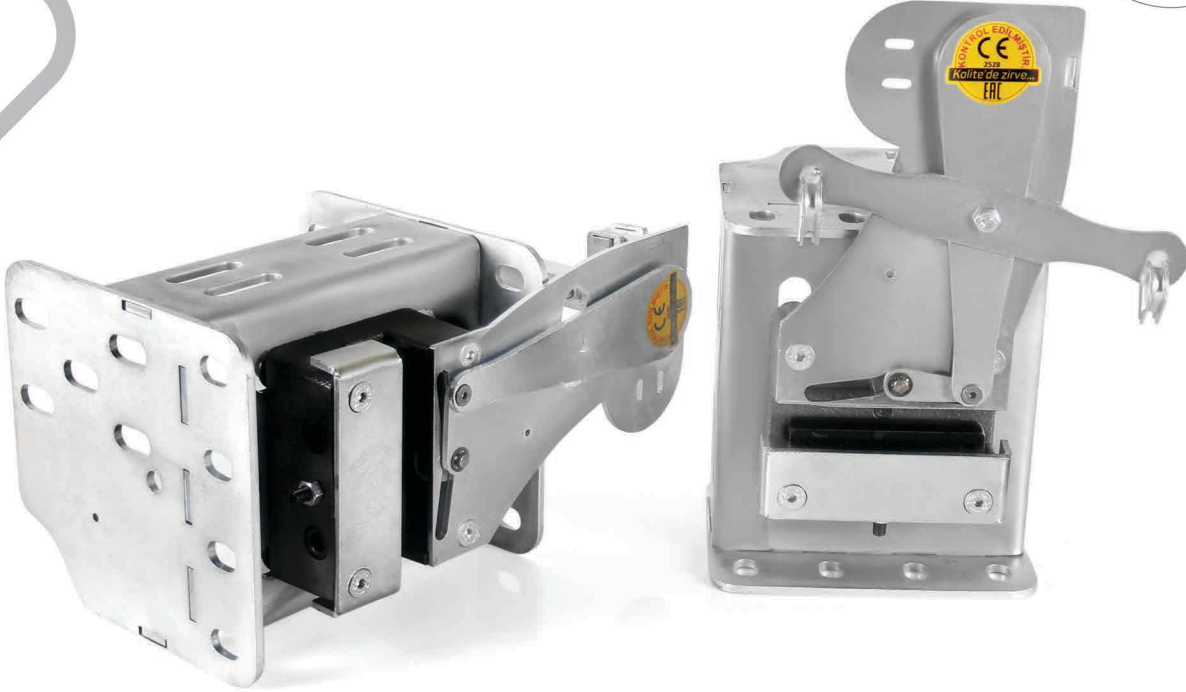

KAYMALI FREN

GLIDING SAFETY
GEAR

فرامل انزلاق

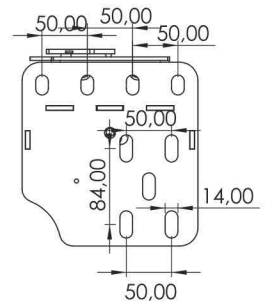
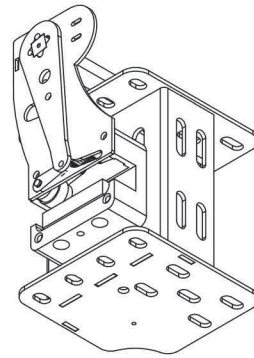
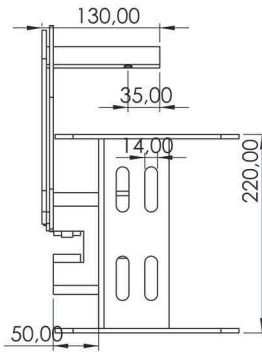
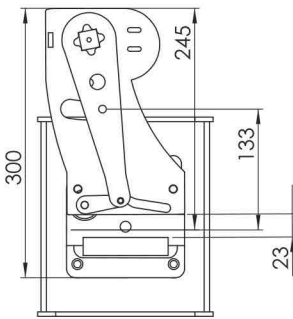

ÜRÜN KOD Product Code كود المنتج

EL9-16 mm (Çift Yön)
EL9 I -16 mm (Tek Yön)

Bidirectional
Single directional

اتجاهين
اتجاه واحد

KAYMALI FREN EMNİYET TERTİBATI

Gliding Safety Gear

فرامل انزلاق

P+Q 1000/4000 KG
HIZ Speed 1.00 M/SN



www.erkanlift.com.tr

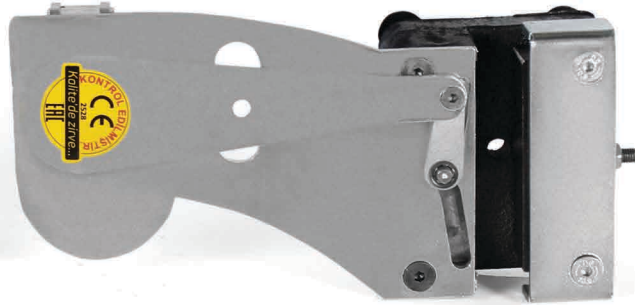
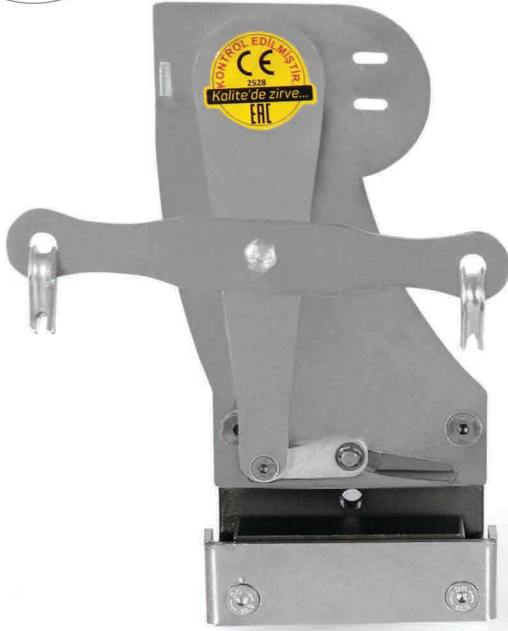

L KARKAS
KAYMALI FREN

CARACASS
SAFETY GEAR

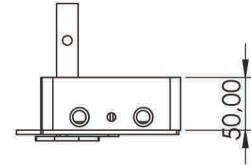
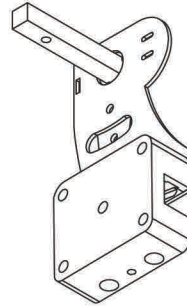
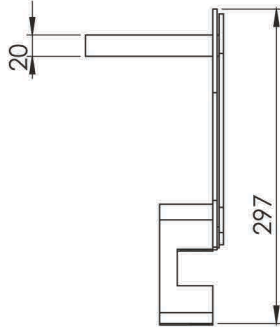
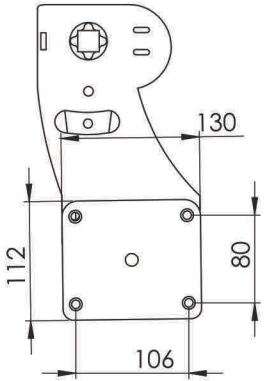

ÜRÜN KOD Product Code كود المنتج

EL9-16 mm (Çift Yön)
EL9I-16 mm (Tek Yön)

Bidirectional
Single directional

اتجاهين
اتجاه واحد

L KARKAS KAYMALI FREN EMNİYET TERTİBATI Caracass Safety Gear فرامل انزلاق بدون قاعدة

P+Q 1000/4000 KG
HIZ Speed 1.00 M/SN

فرامل انزلاق
بدون قاعدة



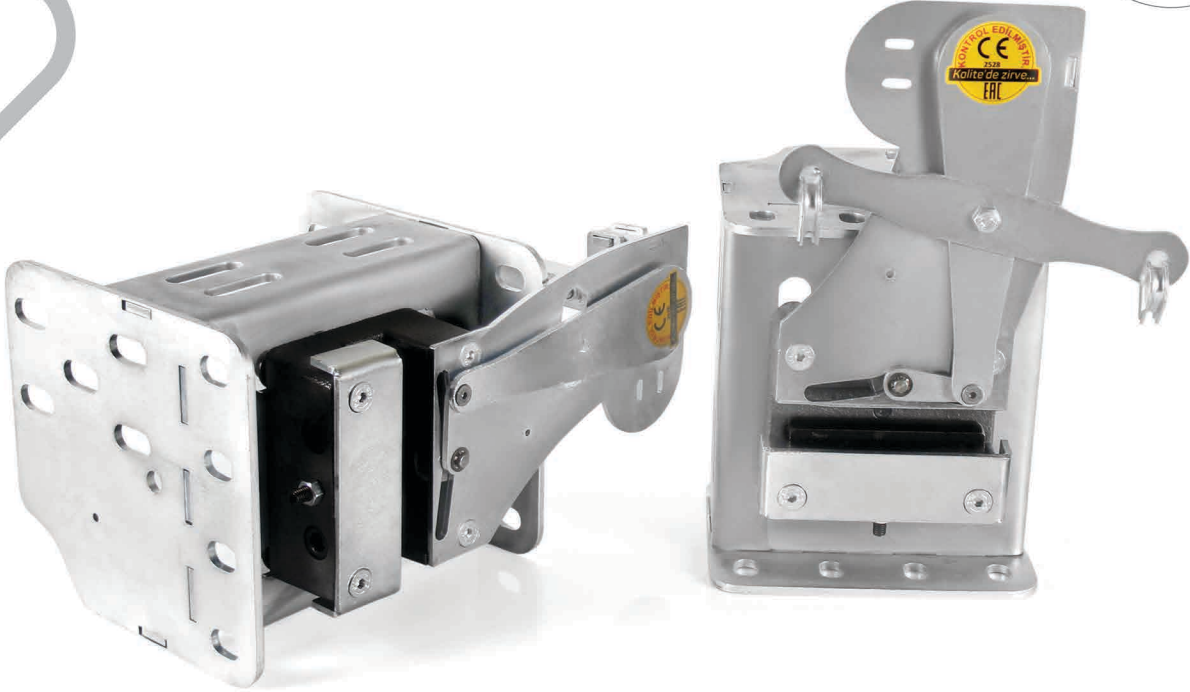

KAYMALI FREN

GLIDING SAFETY
GEAR

فرامل انزلاق

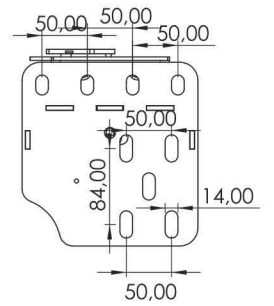
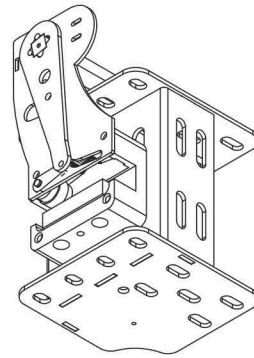
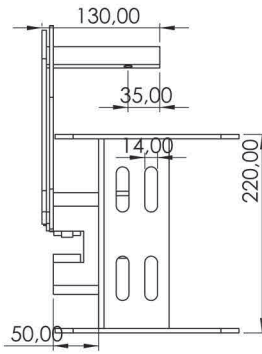
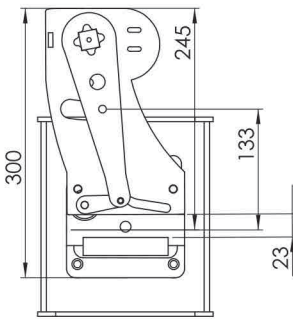

ÜRÜN KOD Product Code كود المنتج

EL9-16 mm (Çift Yön) Bidirectional

اتجاهين

EL9 I -16 mm (Tek Yön) Single directional

اتجاه واحد

KAYMALI FREN EMNİYET TERTİBATI

Gliding Safety Gear

فرامل انزلاق

P+Q 1000/3000 KG
HIZ Speed 1.60 M/SN



www.erkanlift.com.tr

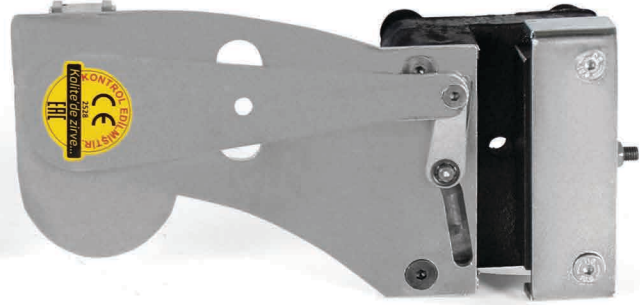

L KARKAS
KAYMALI FREN

CARACASS
SAFETY GEAR

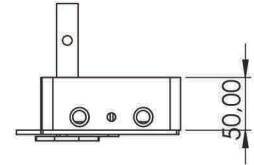
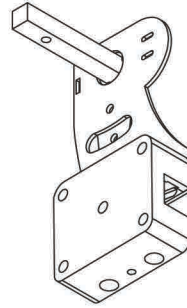
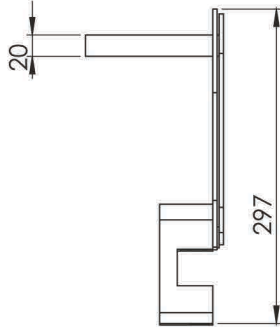
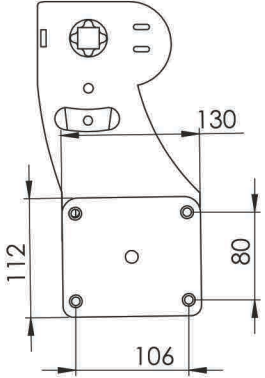

ÜRÜN KOD Product Code كود المنتج

EL9-16 mm (Çift Yön) Bidirectional
EL9 I-16 mm (Tek Yön) Single directional

اتجاهين
اتجاه واحد

L KARKAS KAYMALI FREN EMNİYET TERTİBATI Caracass Safety Gear فرامل انزلاق بدون قاعدة

P+Q 1000/3000 KG
HIZ Speed 1.60 M/SN

فرامل انزلاق
بدون قاعدة



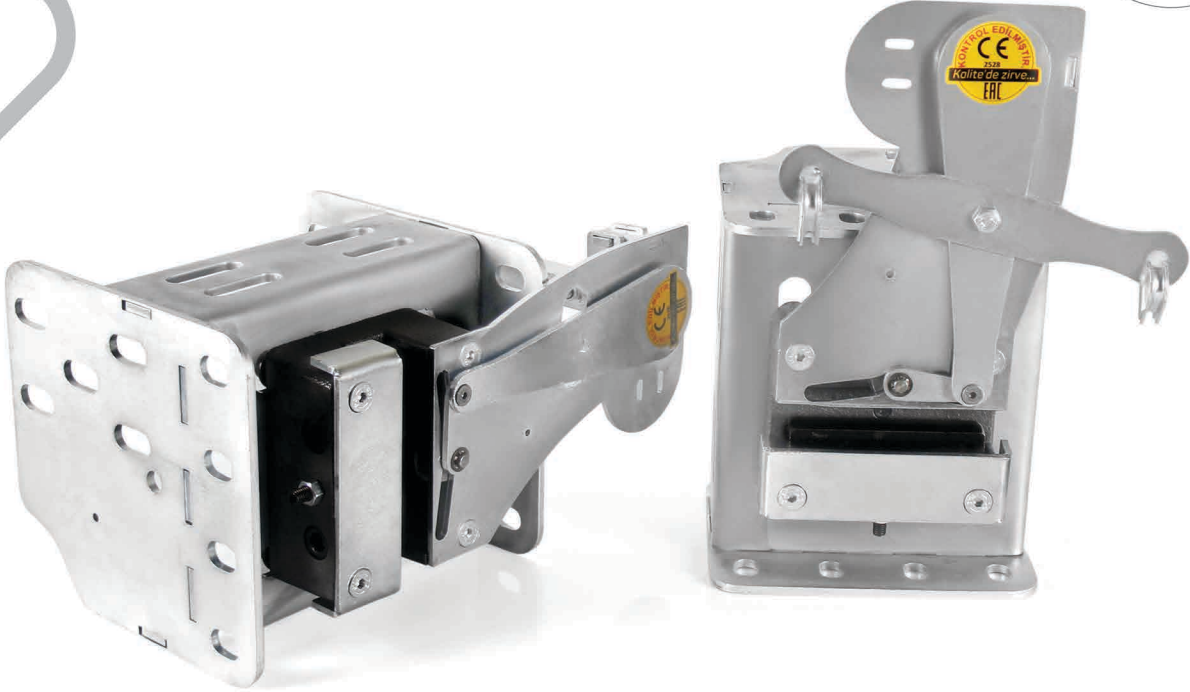

KAYMALI FREN

GLIDING SAFETY
GEAR

فرامل انزلاق

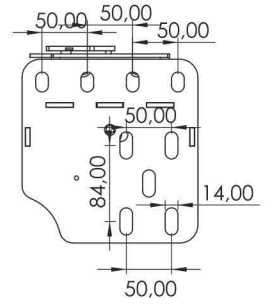
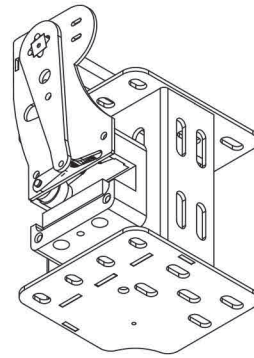
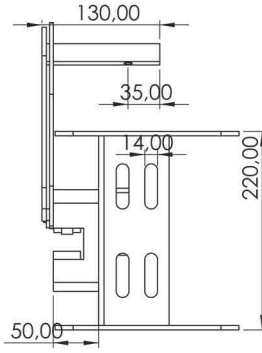
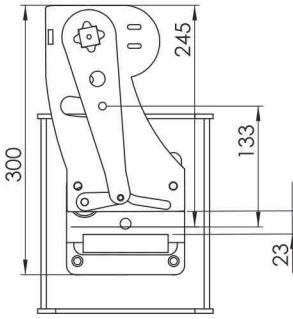

ÜRÜN KOD Product Code كود المنتج

EL9-16 mm (Çift Yön) Bidirectional
EL9 I-16 mm (Tek Yön) Single directional

اتجاهين
اتجاه واحد

KAYMALI FREN EMNİYET TERTİBATI

Gliding Safety Gear

فرامل انزلاق

P+Q 1000/2300 KG
HIZ Speed 2.00 M/SN



www.erkanlift.com.tr

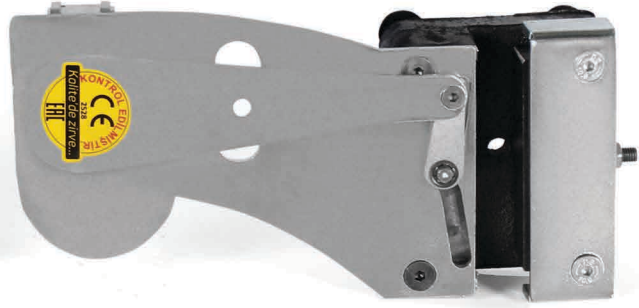

L KARKAS
KAYMALI FREN

CARACASS
SAFETY GEAR

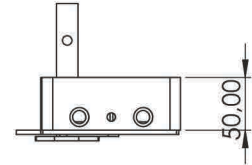
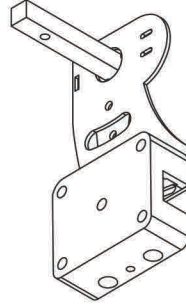
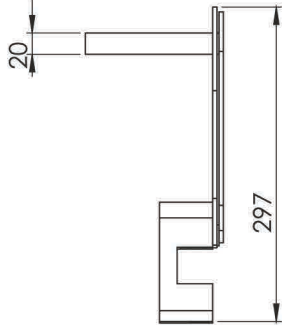
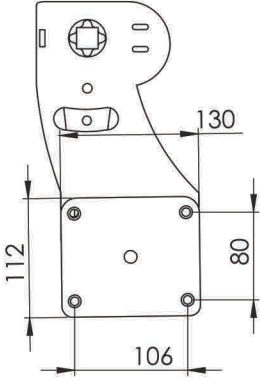

ÜRÜN KOD Product Code كود المنتج

EL9-16 mm (Çift Yön) Bidirectional
EL9 I-16 mm (Tek Yön) Single directional

اتجاهين
اتجاه واحد

L KARKAS KAYMALI FREN EMNİYET TERTİBATI Caracass Safety Gear فرامل انزلاق بدون قاعدة

P+Q 1000/2300 KG
HIZ 2.00 M/SN

فرامل انزلاق
بدون قاعدة

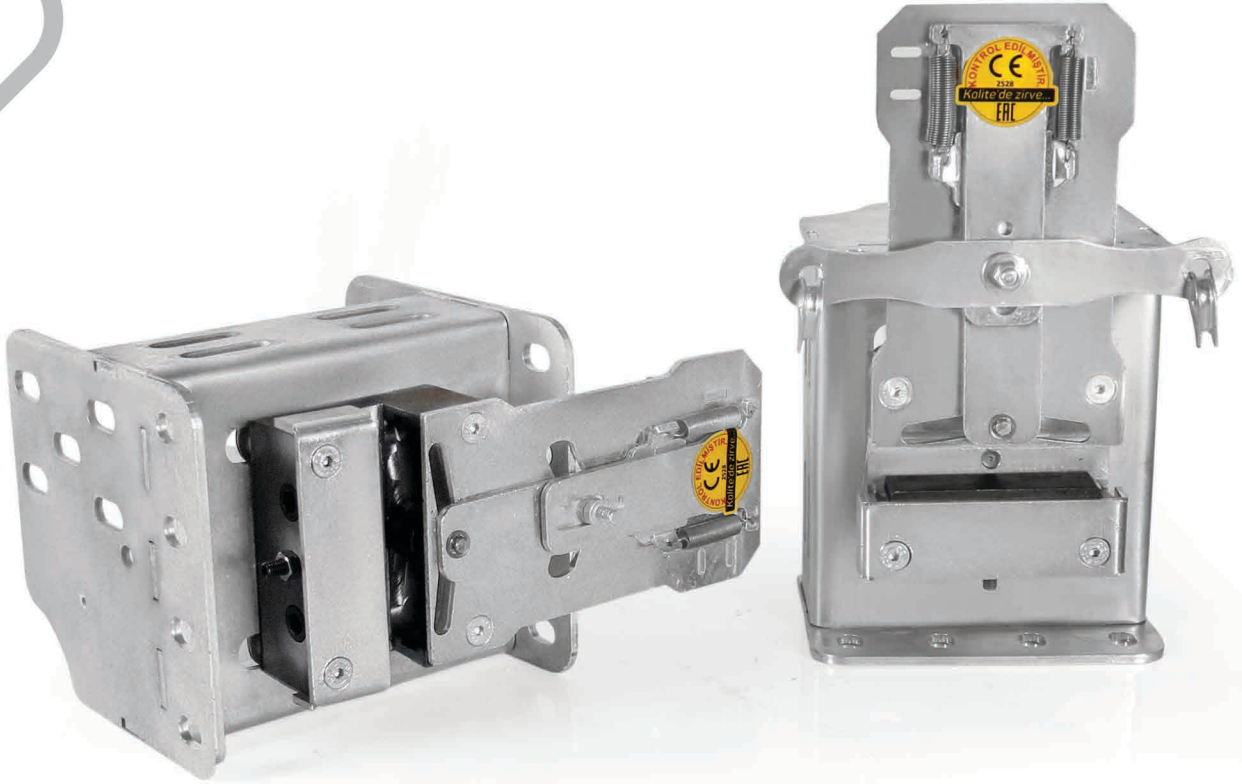

KAYMALI FREN

GLIDING SAFETY
GEAR

فرامل انزلاق

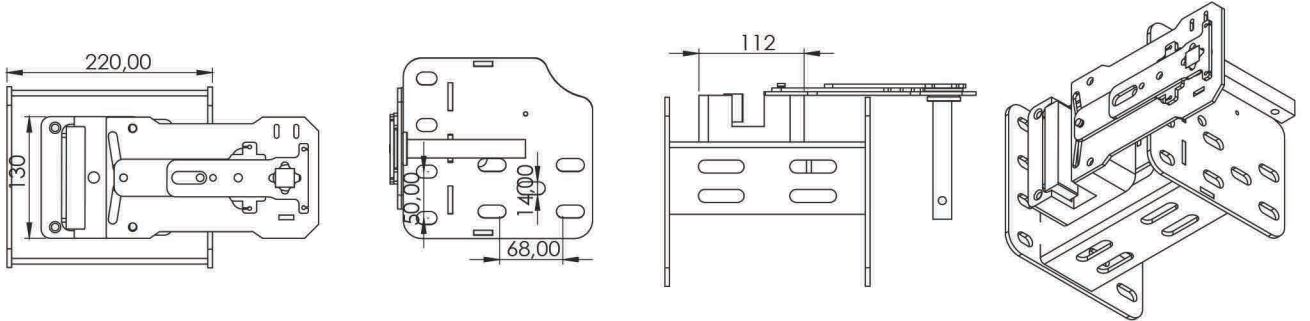

ÜRÜN KOD Product Code كود المنتج

EL8-16 mm (Çift Yön) Bidirectional
EL8 I -16 mm (Tek Yön) Single directional

اتجاهين
اتجاه واحد

KAYMALI FREN EMNİYET TERTİBATI

Gliding Safety Gear

فرامل انزلاق

ÇALIŞMA HIZI Working Speed 1.0 M/SN
P+Q 700/2700 KG
ÇALIŞMA HIZI Working Speed 1.6 M/SN
P+Q 700/2000 KG



www.erkanlift.com.tr

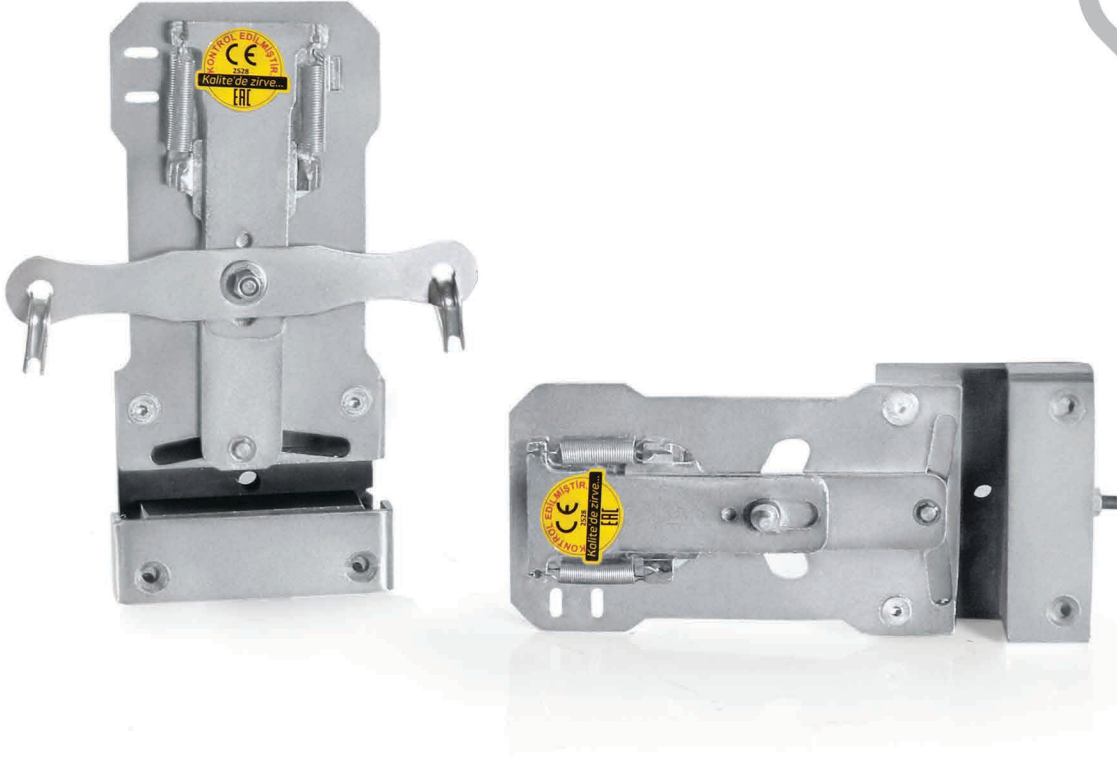

L KARKAS
KAYMALI FREN

CARACASS
SAFETY GEAR

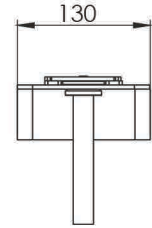
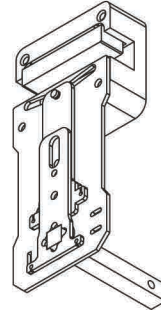
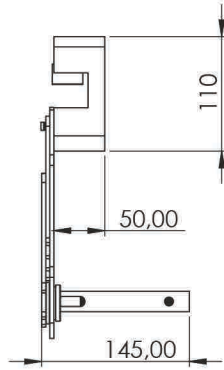
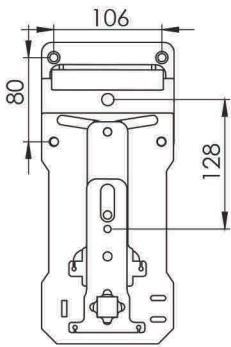

ÜRÜN KOD Product Code كود المنتج

EL8-16 mm (Çift Yön) Bidirectional
EL8 I -16 mm (Tek Yön) Single directional

اتجاهين
اتجاه واحد

L KARKAS KAYMALI FREN EMNİYET TERTİBATI Caracass Safety Gear فرامل انزلاق بدون قاعدة

ÇALIŞMA HIZI Working Speed 1.0 M/SN
P+Q 700/2700 KG
ÇALIŞMA HIZI Working Speed 1.6 M/SN
P+Q 700/2000 KG

فرامل انزلاق
بدون قاعدة

KAYMALI FREN

GLIDING SAFETY
GEAR

فرامل انزلاق

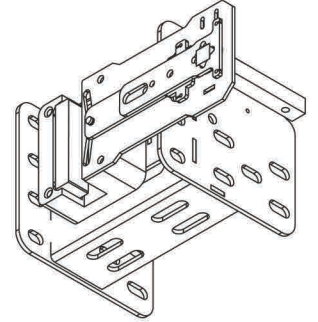
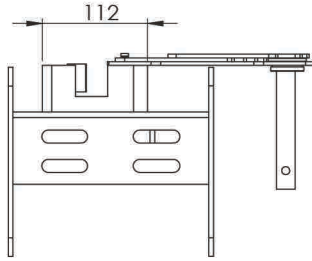
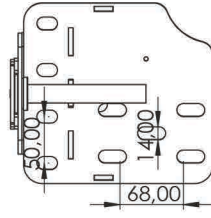
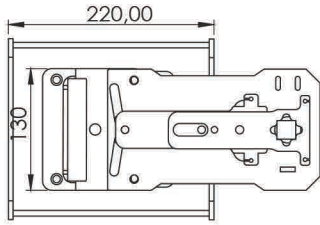
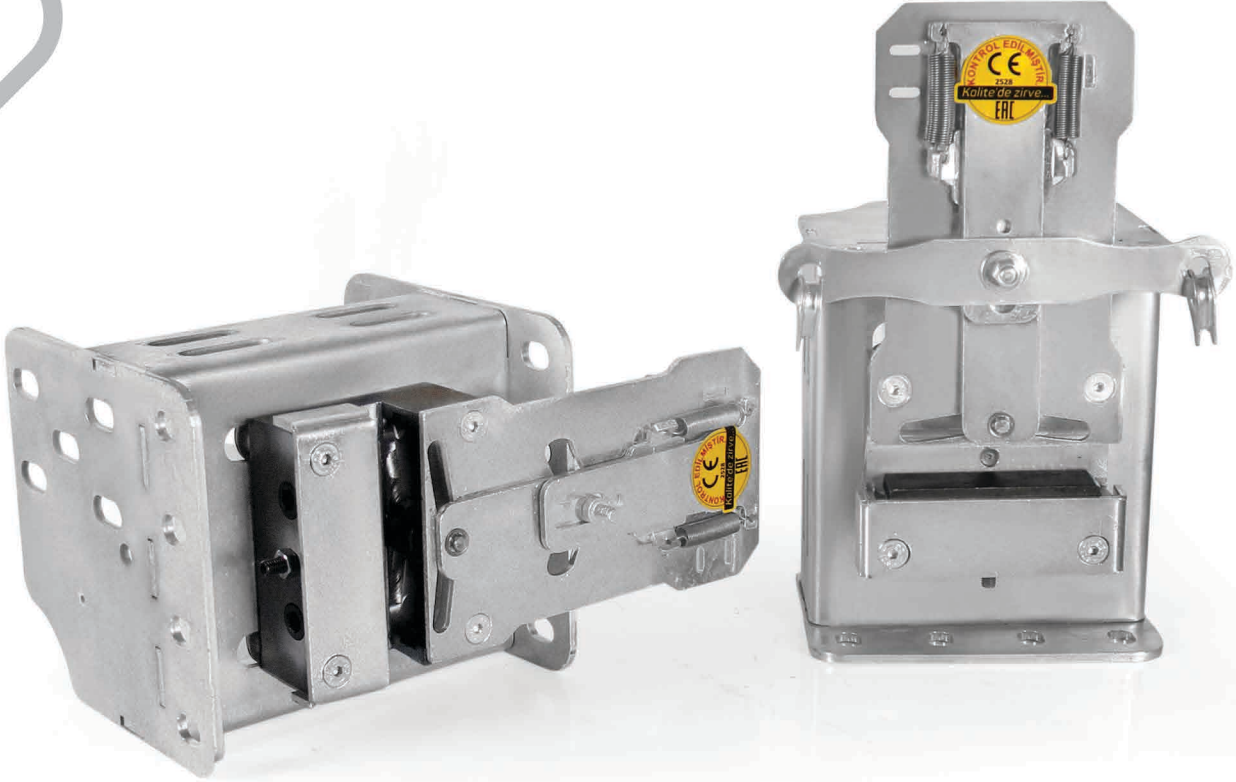

ÜRÜN KOD Product Code كود المنتج

EL7-9 mm (Çift Yön)
EL7 1 -9 mm (Tek Yön)

Bidirectional
Single directional

اتجاهين
اتجاه واحد

KAYMALI FREN EMNİYET TERTİBATI

Gliding Safety Gear

فرامل انزلاق

ÇALIŞMA HIZI Working Speed 1.0 M/SN
P+Q 700/2400 KG
ÇALIŞMA HIZI Working Speed 1.6 M/SN
P+Q 700/2000 KG

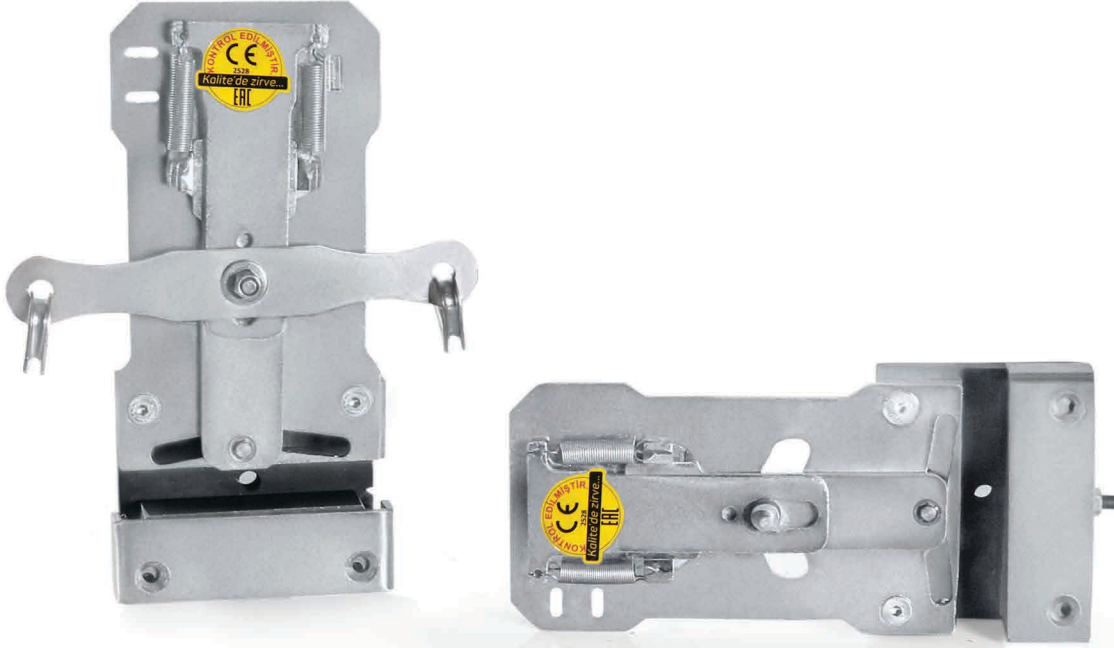

L KARKAS
KAYMALI FREN

CARACASS
SAFETY GEAR

فرامل انزلاق
بدون قاعدة

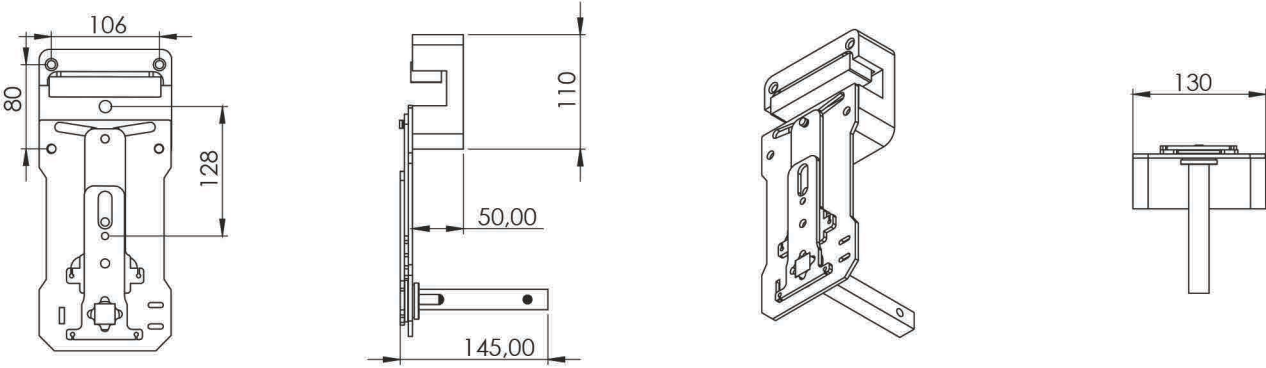

ÜRÜN KOD Product Code كود المنتج

EL7-9 mm (Çift Yön) Bidirectional
EL7 I -9 mm (Tek Yön) Single directional

اتجاهين
اتجاه واحد

L KARKAS KAYMALI FREN EMNİYET TERTİBATI Caracass Safety Gear فرامل انزلاق بدون قاعدة

ÇALIŞMA HIZI Working Speed 1.0 M/SN
P+Q 700/2400 KG
ÇALIŞMA HIZI Working Speed 1.6 M/SN
P+Q 700/2000 KG



KAYMALI FREN

GLIDING SAFETY
GEAR

فرامل انزلاق مزدوجة

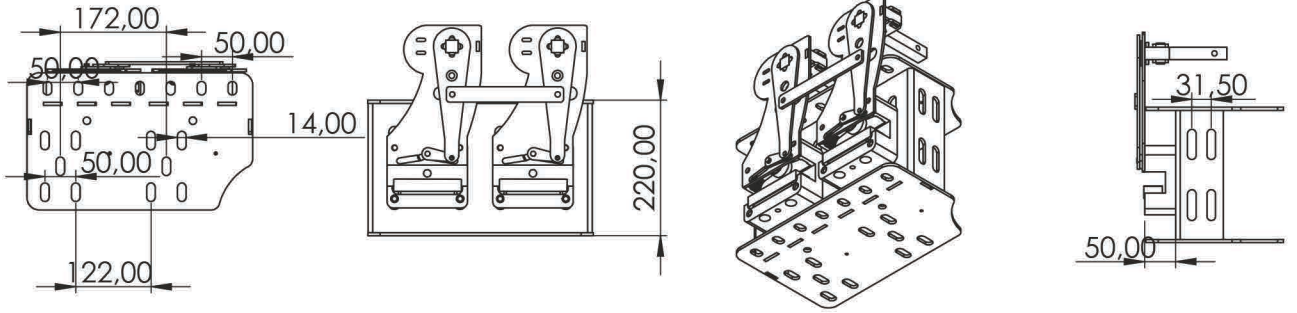
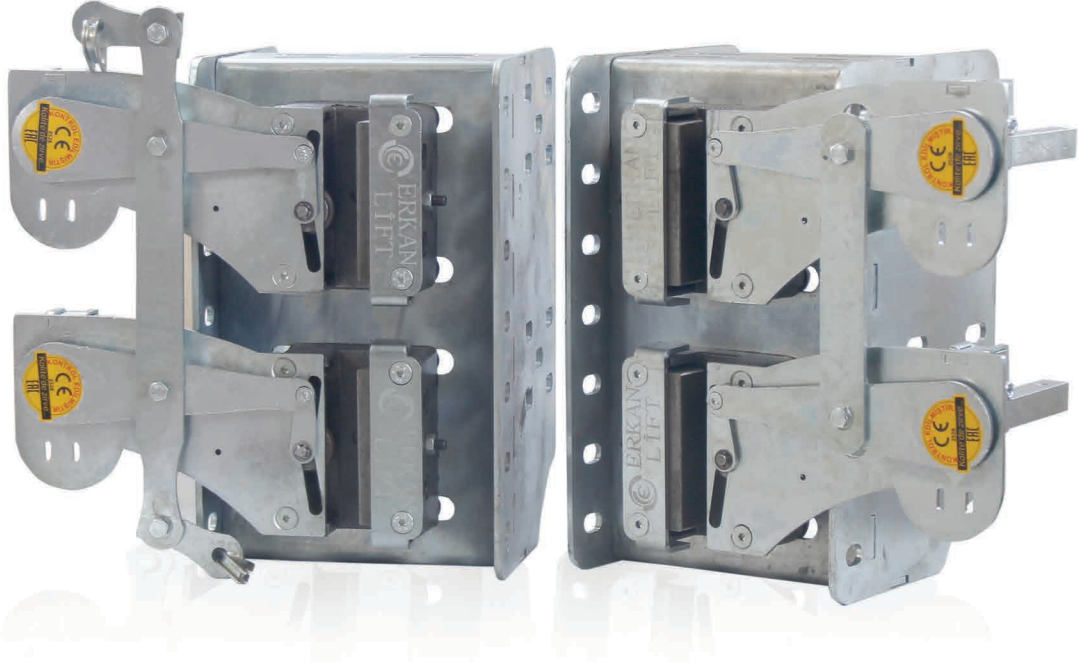

ÜRÜN KOD Product Code كود المنتج

EL10-16 mm

KAYMALI FREN EMNİYET TERTİBATI

Gliding Safety Gear

فرامل انزلاق مزدوجة

ÇALIŞMA HIZI Working Speed 1.0 M/SN

P+Q 1500/6000 KG

ÇALIŞMA HIZI Working Speed 1.6 M/SN

P+Q 1500/4500 KG



www.erkanlift.com.tr

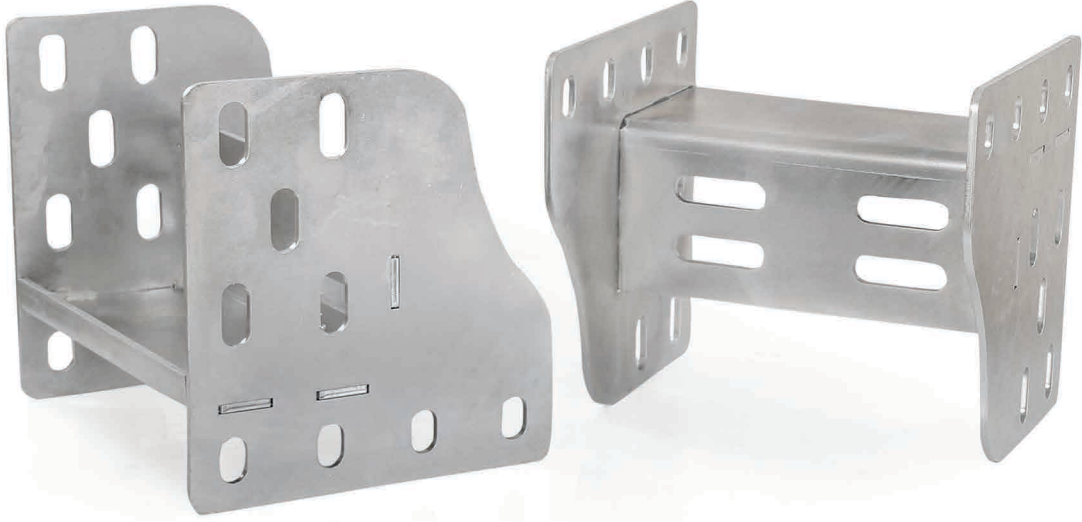

SÜSPANSİYON ALT
TAKIM

SUSPENSION
BOTTOM SET

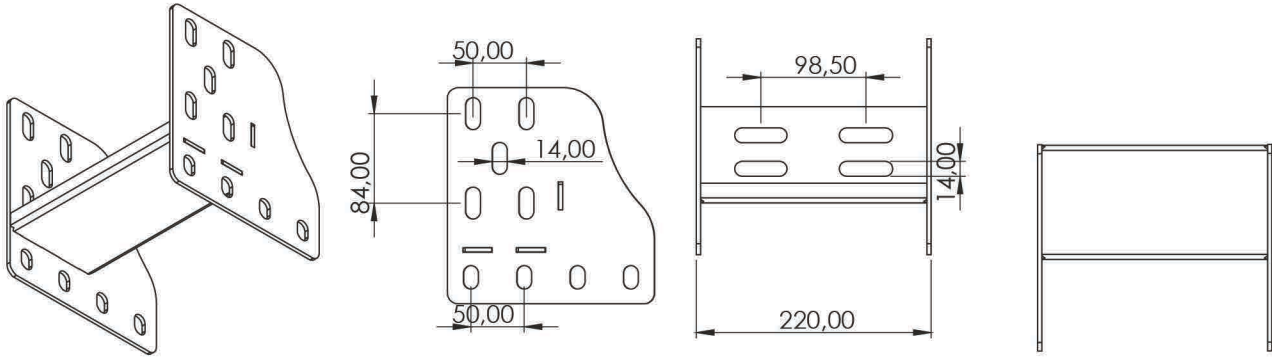

ÜRÜN KOD Product Code كود المنتج

EL-S

SÜSPANSİYON ALT TAKIM Suspension Bottom Set القاعدة السفلية لشاصيه الكابينة

القاعدة السفلية
لشاصيه الكابينة



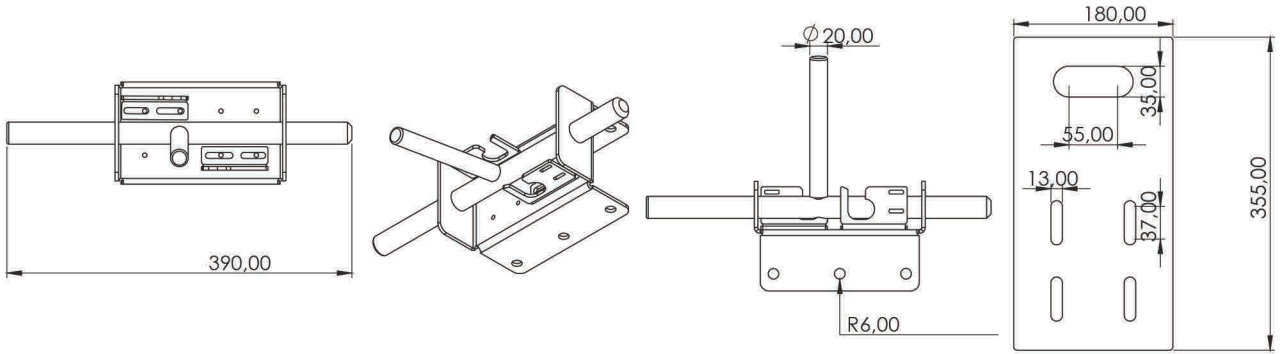
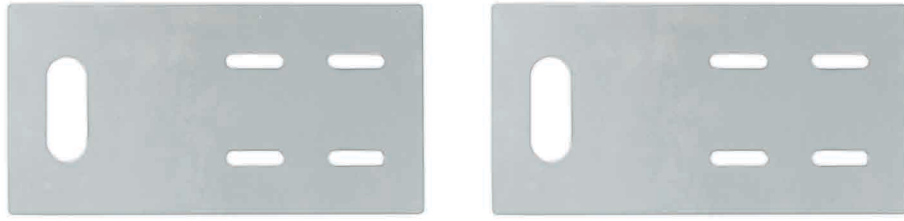
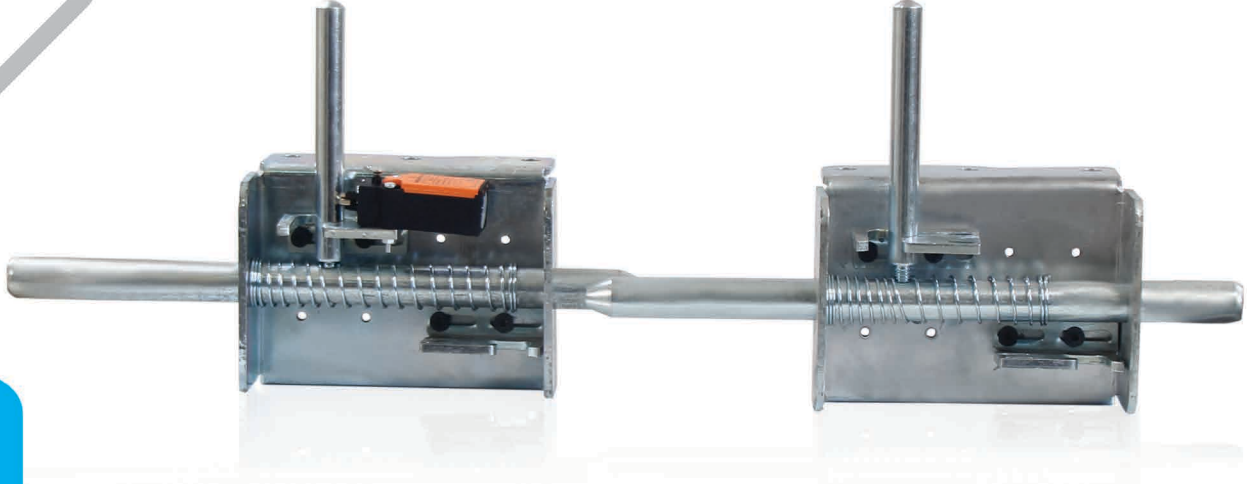

KABİN ASKI APARATI

HANGING APPARATUS

قفل الكابينة

ÜRÜN KOD Product Code كود المنتج

EL-KAA

KABİN ASKI APARATI Hanging Apparatus قفل الكابينة

ASANSÖR GÜVENLİK EKİPMANLARI

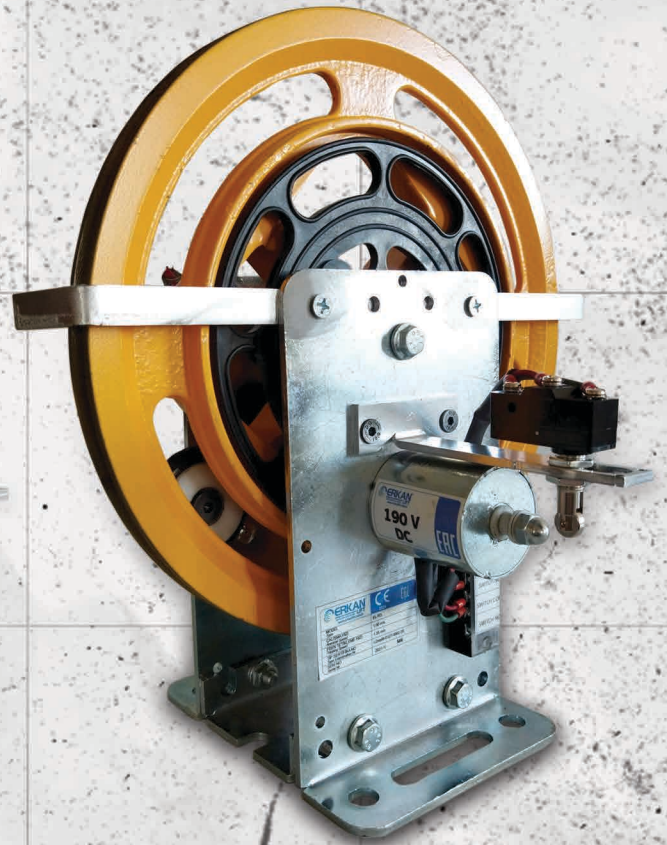
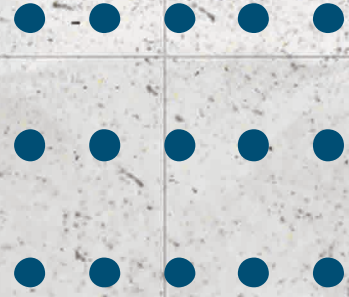

 **ERKAN**[®]
LIFT

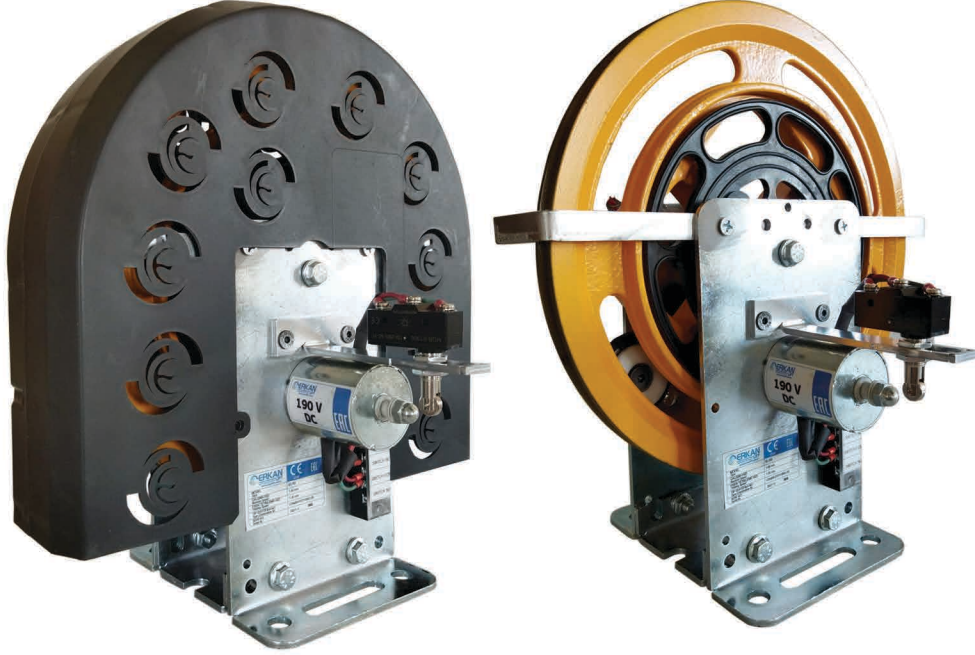

81/20 A3
REGÜLATÖR

81/20 A3
OVERSPEED GOVERNOR

81/20 A3
منظم السرعة

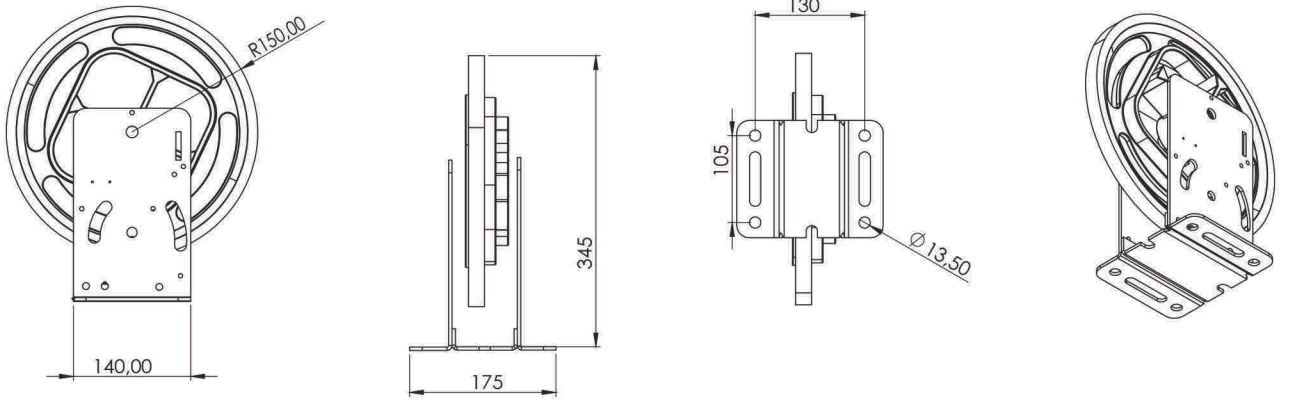

ÜRÜN KOD Product Code كود المنتج

EL-RA3

81/20 BOBİNLİ REGÜLATÖR Overspeed Governor With Coil

منظم السرعة مع ملف

ÇALIŞMA HIZI Working Speed

EL-RA3-1 0.63 M/SN

EL-RA3-2 0.80 M/SN

EL-RA3-3 1.00 M/SN

EL-RA3-4 1.20 M/SN

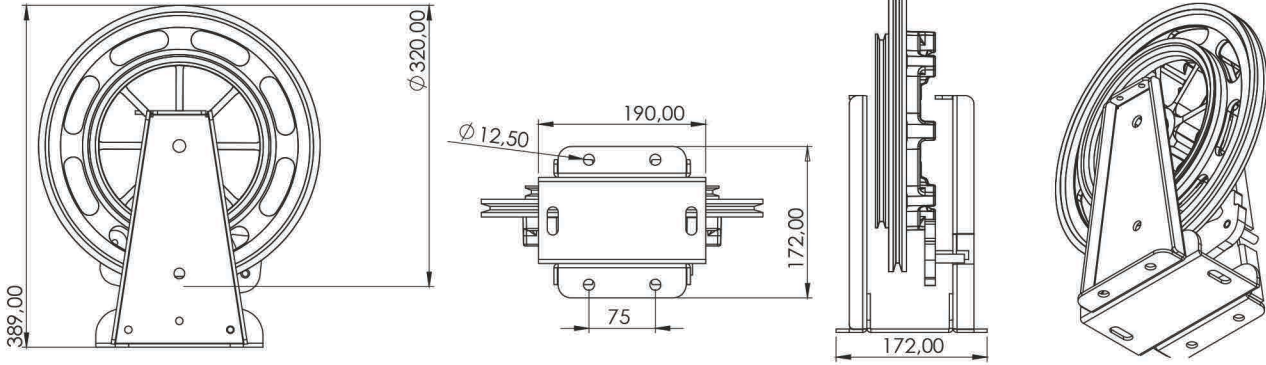
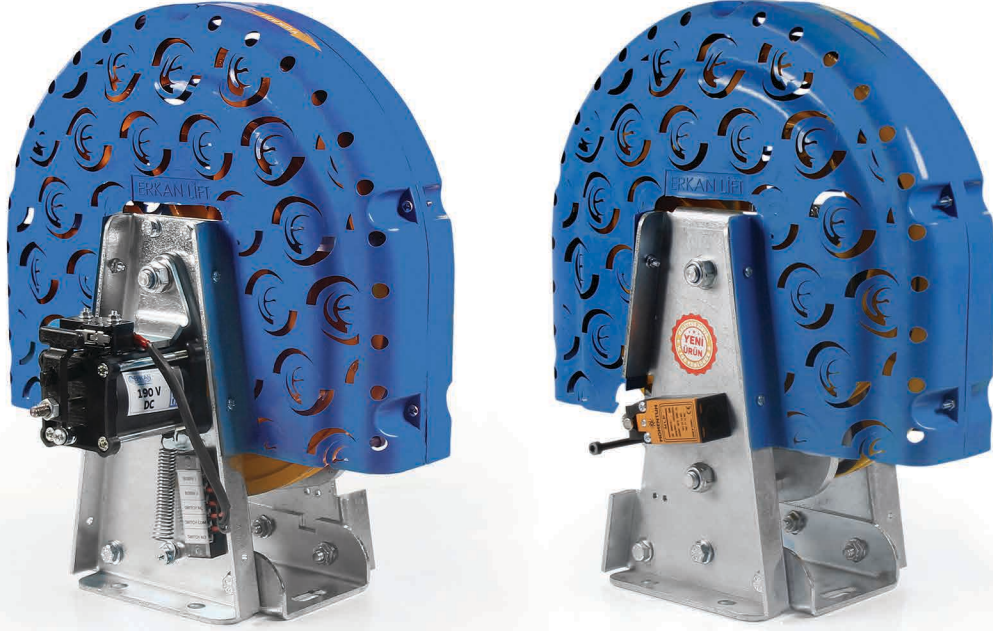

81/20 A3
REGÜLATÖR

81/20 A3
OVERSPEED GOVERNOR

81/20 A3
منظم السرعة

ÜRÜN KOD Product Code كود المنتج

EL-RA3

81/20 BOBİNLİ REGÜLATÖR

Overspeed Governor With Coil

منظم السرعة مع ملف

ÇALIŞMA HIZI Working Speed

EL-RA3-5 1.60 M/SN

EL-RA3-6 2.00 M/SN



UZAKTAN ERİŞİMLİ
REGÜLATÖR

OVERSPEED GOVERNOR
REMOTE ACCESS

منظم السرعة تحكم عن بعد

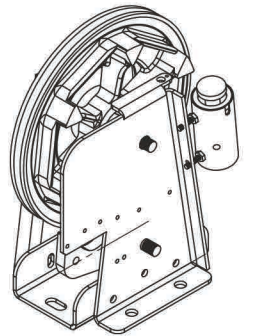
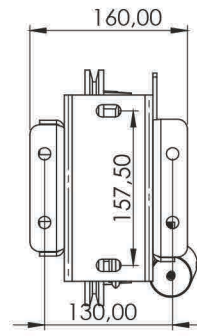
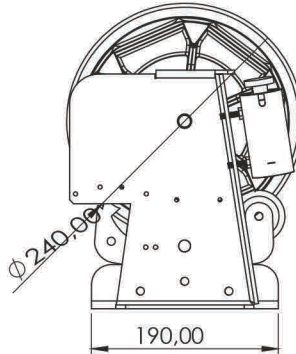
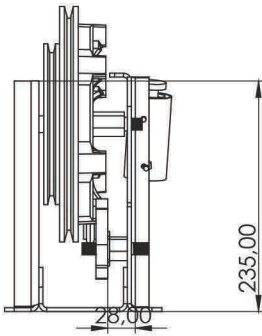

ÜRÜN KOD Product Code كود المنتج

EL-R2K

UZAKTAN ERİŞİMLİ REGÜLATÖR Overspeed Governor Remote Access منظم السرعة تحكم عن بعد

ÇALIŞMA HIZI Working Speed

EL-R2K-1 0.63 M/SN

EL-R2K-2 0.80 M/SN

EL-R2K-3 1.00 M/SN

EL-R2K-4 1.20 M/SN

EL-R2K-5 1.60 M/SN

EL-R2K-6 2.00 M/SN



ÇİFT YÖNLÜ BOBINSİZ
REGÜLATÖR

OVERSPEED GOVERNOR
BIDIRECTIONAL
WITHOUT COIL

منظم السرعة
منظم الاتجاهين بدون ملف

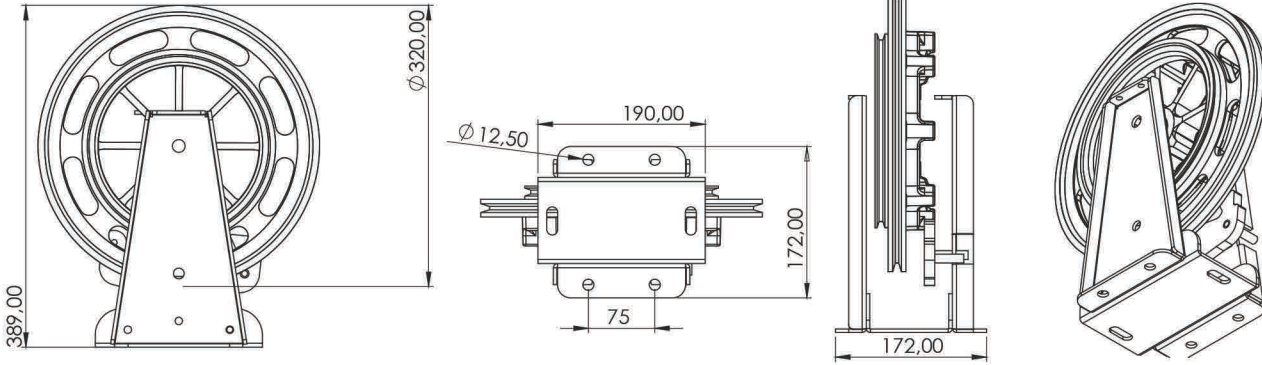

ÜRÜN KOD Product Code كود المنتج

EL-R

BOBINSİZ ÇİFT YÖNLÜ REGÜLATÖR Overspeed Governor Bidirectional Without Coil

منظم السرعة
ذو اتجاهين بدون ملف

ÇALIŞMA HIZI Working Speed

EL-R-1 1.60 M/SN

EL-R-2 2.00 M/SN



81/20 A3
REGÜLATÖR

81/20 A3
OVERSPEED GOVERNOR

81/20 A3
منظم السرعة

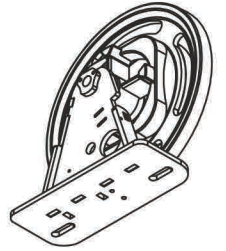
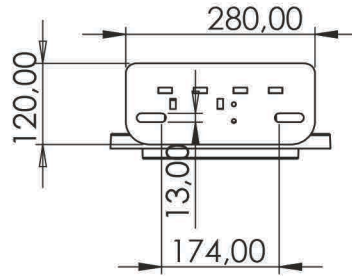
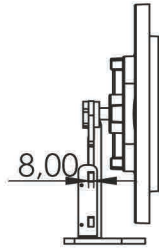
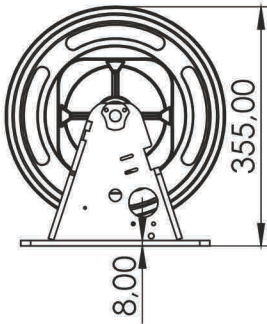

ÜRÜN KOD Product Code كود المنتج

EL-RA3

81/20 BOBİNLİ REGÜLATÖR (SaçMuhafaza) Overspeed Governor With Coil (Cover iron)

منظم السرعة مع ملف
غطاء معدن

ÇALIŞMA HIZI Working Speed

EL-RA3-2 0.80 M/SN
EL-RA3-3 1.00 M/SN
EL-RA3-4 1.20 M/SN
EL-RA3-5 1.60 M/SN
EL-RA3-6 2.00 M/SN



www.erkanlift.com.tr

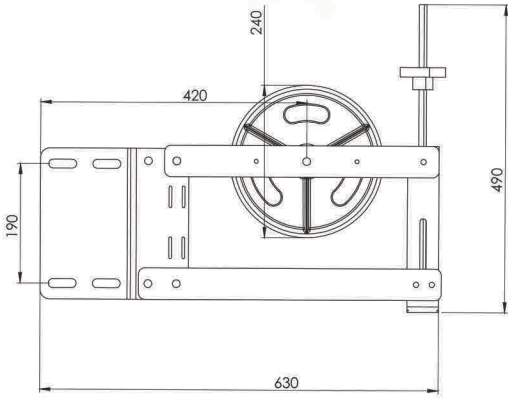
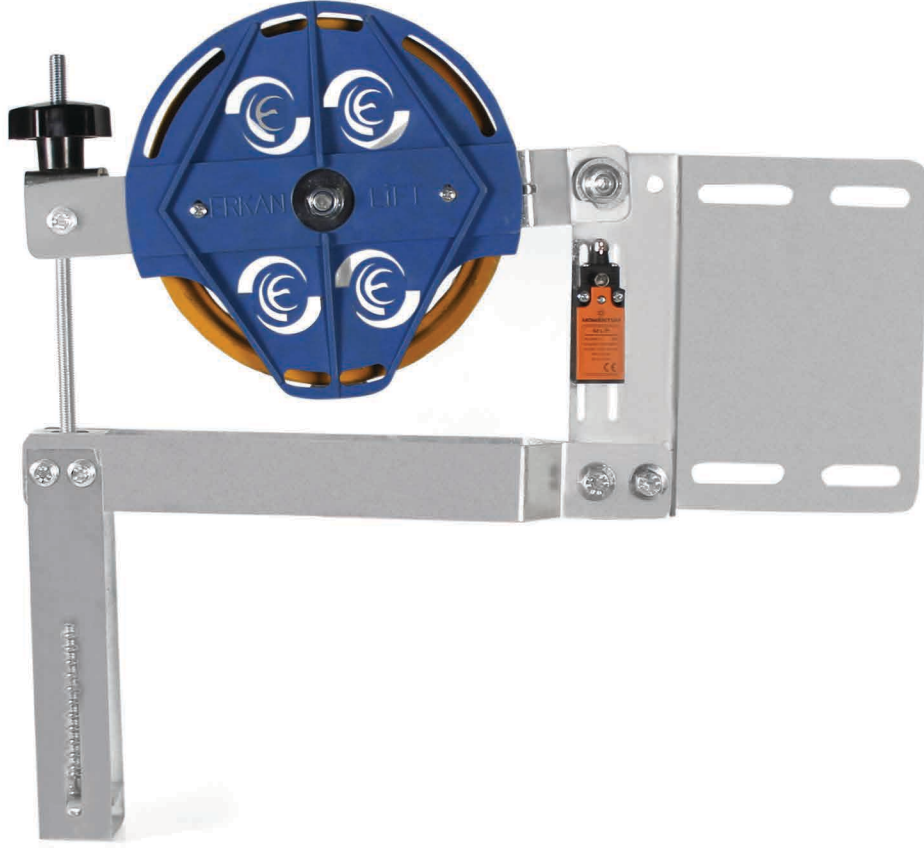

REGÜLATÖR GERĞİ
KASNAĞI (DÖKÜM)

TENSION PULLEY
WITHOUT WEIGHT (IRON)

بكرة الشد لمنظم السرعة

ÜRÜN KOD Product Code كود المنتج

EL-DG

REGÜLATÖR GERĞİ KASNAĞI (Döküm Kasnak) Tension Pulley Without Weight (Iron) بكرة الشد لمنظم السرعة

SİFERO DÖKÜM Ductile cast iron
ÇAP 24 CM Diameter 24 cm
AYARLANABİLİR YAYLI With Adjustable spring

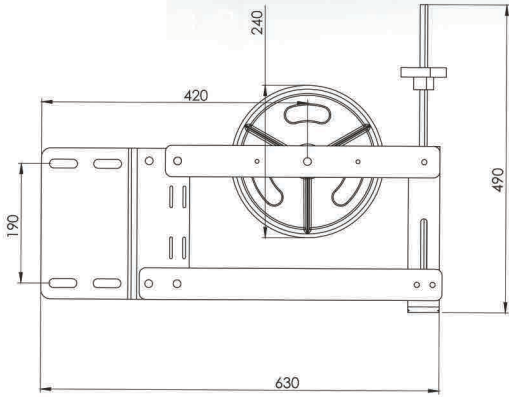
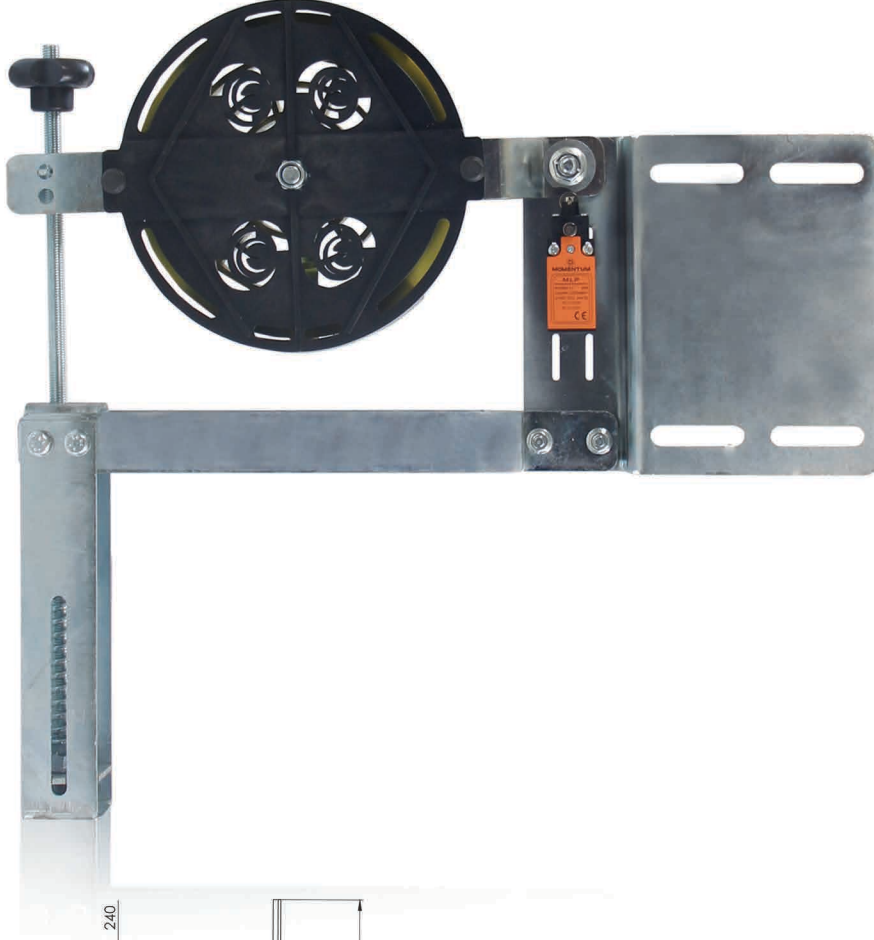

REGÜLATÖR GERĞİ
KASNAĞI (PLASTİK)

TENSION PULLEY
WITHOUT WEIGHT
(PLASTIC)

بكرة الشد لمنظم السرعة
(بلاستيك)

ÜRÜN KOD Product Code كود المنتج

EL-PG

REGÜLATÖR GERĞİ KASNAĞI (Plastik) Tension Pulley Without Weight (Plastic)

بكرة الشد لمنظم السرعة
(بلاستيك)

PLASTK Plastic
ÇAP 24 CM Diameter 24 cm
AYARLANABİLİR YAYLI With Adjustable spring



www.erkanlift.com.tr

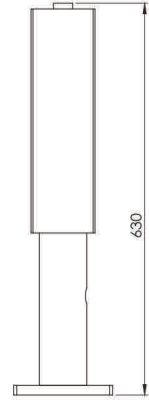
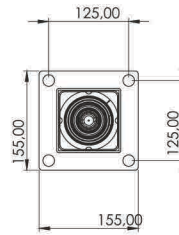
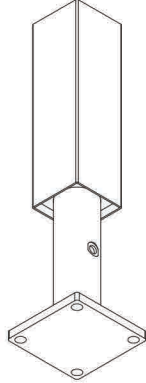
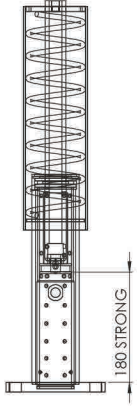

HİDROLİK TAMPON

HYDRAULIC BUFFER

ممتص صدمات هيدروليكي

ÜRÜN KOD Product Code كود المنتج

EL-HT

HİDROLİK TAMPON Hydraulic Buffer ممتص صدمات هيدروليكي

ÇALIŞMA KAPASİTESİ Working Capacity
1.0 M/SN 2.500 KG
1.60 M/SN 2.000 KG
2.00 M/SN 1.750 KG

TAMPON YÜKSELİĞİ Height 630 MM
STROK 180 MM
YAG TİPİ Oil Type ISO VG 68



HAREKETLİ SAC
PATEN

GUIDE SHOES

كرسي الكابينة المتحرك

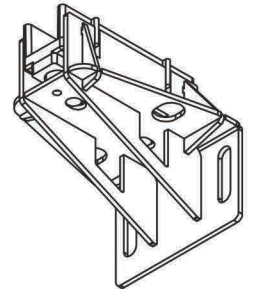
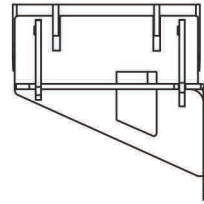
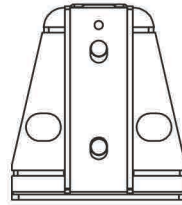
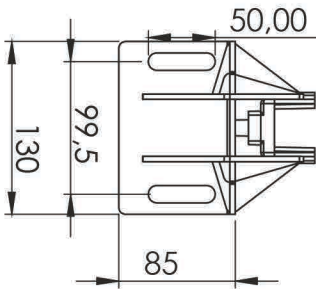

ÜRÜN KOD Product Code كود المنتج

EL-P

PATEN Guide Shoes كرسى الكابينة المتحرك

KOLAY DEĞİŞEBİLİR PATEN AĞIZLARI Easy Changeable Guide Shoes

5 MM
9 MM
16 MM

ASANSÖR GÜVENLİK EKİPMANLARI





ÇAP 210
PLANGA KASNAĞI

PULLEY DIAMETER 210

بكرة قطر

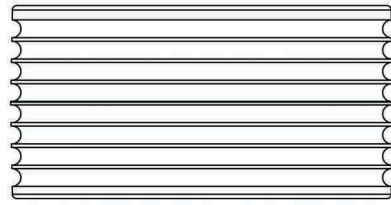
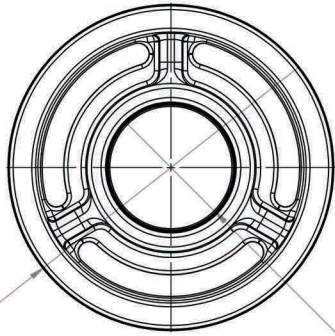

ÜRÜN KOD Product Code كود المنتج

EL-K210

ÇAP 210 MM PLANGA KASNAĞI (DÖKÜM) 210 MM Pulley بكرة قطر 210 ملم

KASNAK ÇAPI Pulley Diameter 210 MM
MİL ÇAPI Mil Diameter 50 MM
RULMAN Bearing ZZ6210

ZİRVEDEKİ
EMNİYETİNİZ

www.erkanlift.com.tr

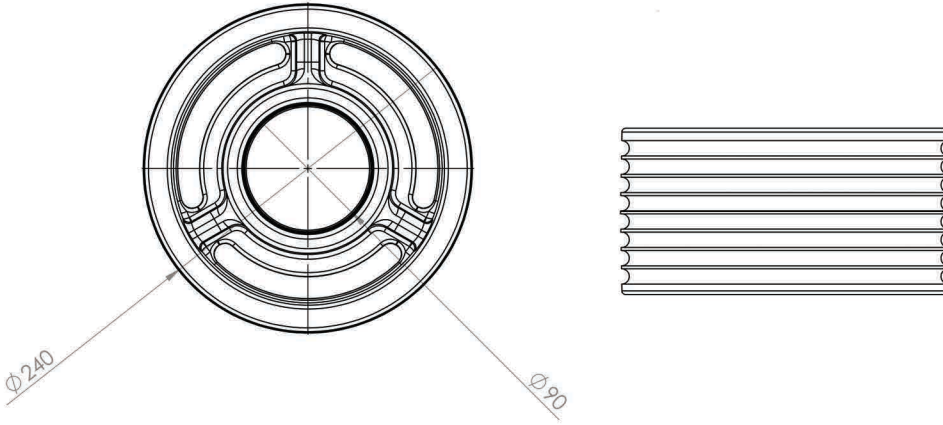

ÇAP 240
PLANGA KASNAĞI

PULLEY DIAMETER 240

بكرة قطر

ÜRÜN KOD Product Code كود المنتج

EL-K240

ÇAP 240 MM PLANGA KASNAĞI (DÖKÜM) 210 MM Pulley بكرة قطر 240 ملم

KASNAK ÇAPI Pulley Diameter 240 MM
MİL ÇAPI Mil Diameter 50 MM
RULMAN Bearing ZZ6210



ÇAP 320
PLANGA KASNAĞI

PULLEY DIAMETER 320

بكرة قطر

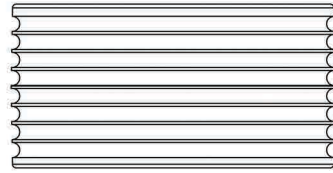
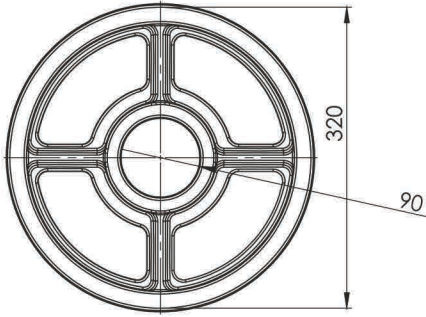

ÜRÜN KOD Product Code كود المنتج

EL-K320

ÇAP 320 MM PLANGA KASNAĞI (DÖKÜM) 320 MM Pulley بكرة قطر 320 ملم

KASNAK ÇAPI Pulley Diameter 320 MM
MİL ÇAPI Mil Diameter 50 MM
RULMAN Bearing ZZ6210

ZİRVEDEKİ
EMNİYETİNİZ

www.erkanlift.com.tr

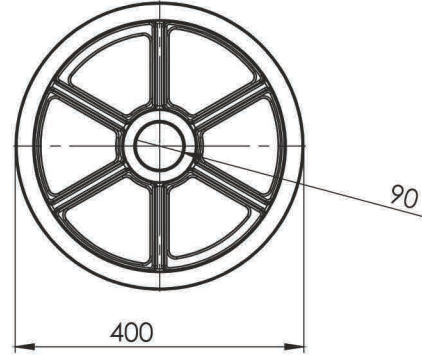
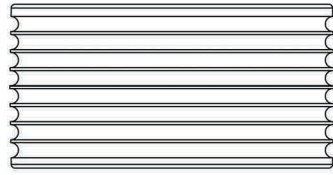

ÇAP 400
PLANGA KASNAĞI

PULLEY DIAMETER 400

بكرة قطر

ÜRÜN KOD Product Code كود المنتج

EL-K400

ÇAP 400 MM PLANGA KASNAĞI (DÖKÜM) 400 MM Pulley بكرة قطر 400 ملم

KASNAK ÇAPI Pulley Diameter 400 MM
MİL ÇAPI Mil Diameter 50 MM
RULMAN Bearing ZZ6210

AŞANSÖR GÜVENLİK EKİPMANLARI



www.erkanlift.com.tr



ALÜMİNYUM
KÜPEŞTE BAŞLIĞI

ALUMINIUM HANDRAIL
HEAD

مقبض المنيوم

ÜRÜN KOD Product Code كود المنتج

EL-ALKG

ALÜMİNYUM KÜPEŞTE Aluminium Handrail Head مقبض المنيوم فضي

25'LİK BORU 25 mm pipe
25'LİK BORUYA UYUMLU KÜPEŞTE BAŞLIĞI Suitable to 25 mm Hand Rail Head





SARI ELEKSAL
ALÜMİNYUM
KÜPEŞTE BAŞLIĞI

YELLOW ANODIZED
ALUMINIUM HANDRAIL
HEAD

مقبض المنيوم

ÜRÜN KOD Product Code كود المنتج

EL-ALKS

SARI ELEKSAL ALÜMİNYUM KÜPEŞTE BAŞLIĞI Yellow Anodized Aluminium Handrail Head مقبض المنيوم

25'LİK BORU 25 mm pipe
25'LİK BORUYA UYUMLU KÜPEŞTE BAŞLIĞI Suitable to 25 mm Hand Rail Head



www.erkanlift.com.tr



KROM KÜPEŞTE

CHROME HANDRAIL

مقبض ستانلس

ÜRÜN KOD Product Code كود المنتج

EL-KK

KROM KÜPEŞTE Chrome Handrail مقبض ستانلس

32 MM ÇAPINDA 304 KALİTE KROM İSTENİLEN BOY VE DELİK ARASI ÖLÇÜLERE UYGUN ÜRETİLMEKTEDİR.
32mm Diameter 304 Quality Chrome Desired Length And Dimensions Between Hole Suitable Manufactured



53



ALÜMİNYUM
PROFİL KÜPEŞTE

ALUMINIUM PROFILE
HANDRAIL

مقبض المنيوم

ÜRÜN KOD Product Code كود المنتج

EL-APK

ALÜMİNYUM PROFİL KÜPEŞTE Aluminium Profile Handrail مقبض المنيوم

35 MM ÇAPINDA 600 CM UZUNLUĞUNDA İSTENİLEN BOY ÖLÇÜSÜ VE DELİK ARASI ÖLÇÜSÜ AYARLANABİLEN ÖZELLİĞE SAHİPTİR.
3 RENK SEÇENEĞİ İLE KABİNLERİNİZDE DEKORATİF ESTETİK VE KOLAY MONTAJ. DÖNÜŞ DİRSEKLERİDE MEVCUTTUR.

35 mm diameter 600 cm length it has the feature that can be adjusted to the desired length size and the hole measurement. decorative
aesthetic and easy assembly in cabinets with 3 color options. available on return elbows.

ZİRVEDEKİ
EMNİYETİNİZ

www.erkanlift.com.tr



PLEKSİ KÜPEŞTE

PLEXI HANDRAIL

مقبض بلیکسی

ÜRÜN KOD Product Code كود المنتج

EL-PK

PLEKSİ KÜPEŞTE Plexi Handrail مقبض بلیکسی

30 MM ALÜMİNYUM DEKORATİF BAŞLIKLI PLEKSİ MALZEME İLE ÜRETİLMİŞTİR.
30 mm aluminum decorative head made with plexy material.

55

CE EAC
2528



KÜPEŞTE DİRSEK

ELBOW HANDRAIL

قاعدة بلاستيك لمقبض
الكابينة

ÜRÜN KOD Product Code كود المنتج

EL-PD

KÜPEŞTE DİRSEK Elbow Handrail قاعدة بلاستيك لمقبض الكابينة

35 MM'LİK PROFİL KÜPEŞTE DİRSEKLERİ PLASTİK
35 mm Profile Handrail Elbows Plastic

AB TİP İNCELEME SERTİFİKASI
No: LDsq08-0228-0112-22

ERKAN ALÜMİNYUM ASANSÖR İNŞAAT DİŞ TİCARET SAN. VE TİC. LTD. ŞTİ.
Tatlıcaik Mah. Kıkırcılar Sok. No:38 - Karatay, Konya, Türkiye

D KARE GÖZETİM TEST VE BEĞELİRME T.C. LTD. ŞTİ. yalıında unvanı belirlen firması Ürettici ve yapıda teknik özellikler belirlenmiş olan asansör gövencesi akşamın, 2014/33/AB Asansör Yönetmeliğinin 1 numarası Ekinde belirlenen Temel Sağlık ve Güvenlik Kuralları karşılığında değerlendirilmiş olup, onaylanmıştır.

2014/33/AB Ek IV/A Asansör Gövencesi İçin AB Tip İncelemesi (Modül B) ÖRÜNÜ:
Tanim : :2014/33/AB Asansör Yönetmeliği Ek'Fin 3.2. maddesinde bahsi geçen ölçümleri Önlöyen yapı kabini ölçümleri veya kontrolüz hareketini engelleyen tertibatlar
: CPT Yöneli Kaldırma Gövencesi Tertibatı

Adı : ERKANLIFT
Markası : ERKANLIFT
Tipi : EL
Tipi Varyasyonları : EL-8
Temel Özellikler : Azami devreye girme hızı: 1,50 m/s, Azami kapasite: 2400 kg
Azami devreye girme hızı: 2,16 m/s, Azami kapasite: 2000 kg
Sertifika ekinde detaylandırılmıştır.

Bu sertifika ve ekinde belirlenen tip ve ekipman üzerinde gerçekleştirilecek değişiklikler veya ilgili standart üzerinde meydana gelebilecek değişiklik durumunda sertifikanın geçerliliği D KARE tarafından yeniden değerlendirilmelidir.
Bu sertifika 24/02/2022 tarihli ve LDsq08-0224-0113-22 numaralı final raporda belirlenen bulgular doğrultusunda düzenlenmiştir.
Gövencik ekipmanın uygulanışının değerlendirilmesi sırasında TS EN 81-20:2020 ve TS EN 81-50:2020 standartlarında belirlenen muayene ve deney metotları kullanılmıştır.

Selcan GÖRMÜŞ
Genel Müdür

Yayın Tarihi : 28 Şubat 2022
Geçerlilik Tarihi : 27 Şubat 2027

Genel Mah. Her Yönü St. Dröğes Park Plaza No:10 D:13 Mahallesi - 07100000
Tel: 032 260 18 76, Fax: 032 260 18 76, web: www.erkancan.com.tr, e-posta: info@erkancan.com.tr

AB TİP İNCELEME SERTİFİKASI
No: LDsq08-0228-0112-22

ERKAN ALÜMİNYUM ASANSÖR İNŞAAT DİŞ TİCARET SAN. VE TİC. LTD. ŞTİ.
Tatlıcaik Mah. Kıkırcılar Sok. No:38 - Karatay, Konya, Türkiye

D KARE GÖZETİM TEST VE BEĞELİRME T.C. LTD. ŞTİ. yalıında unvanı belirlen firması Ürettici ve yapıda teknik özellikler belirlenmiş olan asansör gövencesi akşamın, 2014/33/AB Asansör Yönetmeliğinin 1 numarası Ekinde belirlenen Temel Sağlık ve Güvenlik Kuralları karşılığında değerlendirilmiş olup, onaylanmıştır.

2014/33/AB Ek IV/A Asansör Gövencesi İçin AB Tip İncelemesi (Modül B) ÖRÜNÜ:
Tanim : :2014/33/AB Asansör Yönetmeliği Ek'Fin 3.2. maddesinde bahsi geçen ölçümleri Önlöyen yapı kabini ölçümleri veya kontrolüz hareketini engelleyen tertibatlar
: Yak Yöneli Kaldırma Gövencesi Tertibatı

Adı : ERKANLIFT
Markası : ERKANLIFT
Tipi : EL
Tipi Varyasyonları : EL-8
Temel Özellikler : Azami devreye girme hızı: 1,50 m/s, Azami kapasite: 4000 kg
Azami devreye girme hızı: 2,16 m/s, Azami kapasite: 3000 kg
Azami devreye girme hızı: 2,62 m/s, Azami kapasite: 2500 kg
Sertifika ekinde detaylandırılmıştır.

Bu sertifika ve ekinde belirlenen tip ve ekipman üzerinde gerçekleştirilecek değişiklikler veya ilgili standart üzerinde meydana gelebilecek değişiklik durumunda sertifikanın geçerliliği D KARE tarafından yeniden değerlendirilmelidir.
Bu sertifika 22/02/2022 tarihli ve LDsq08-0225-0115-22 numaralı final raporda belirlenen bulgular doğrultusunda düzenlenmiştir.
Gövencik ekipmanın uygulanışının değerlendirilmesi sırasında TS EN 81-20:2020 ve TS EN 81-50:2020 standartlarında belirlenen muayene ve deney metotları kullanılmıştır.

Selcan GÖRMÜŞ
Genel Müdür

Yayın Tarihi : 28 Şubat 2022
Geçerlilik Tarihi : 27 Şubat 2027

Genel Mah. Her Yönü St. Dröğes Park Plaza No:10 D:13 Mahallesi - 07100000
Tel: 032 260 18 76, Fax: 032 260 18 76, web: www.erkancan.com.tr, e-posta: info@erkancan.com.tr

AB TİP İNCELEME SERTİFİKASI
No: LDsq08-0228-0115-22

ERKAN ALÜMİNYUM ASANSÖR İNŞAAT DİŞ TİCARET SAN. VE TİC. LTD. ŞTİ.
Tatlıcaik Mah. Kıkırcılar Sok. No:38 - Karatay, Konya, Türkiye

D KARE GÖZETİM TEST VE BEĞELİRME T.C. LTD. ŞTİ. yalıında unvanı belirlen firması Ürettici ve yapıda teknik özellikler belirlenmiş olan asansör gövencesi akşamın, 2014/33/AB Asansör Yönetmeliğinin 1 numarası Ekinde belirlenen Temel Sağlık ve Güvenlik Kuralları karşılığında değerlendirilmiş olup, onaylanmıştır.

2014/33/AB Ek IV/A Asansör Gövencesi İçin AB Tip İncelemesi (Modül B) ÖRÜNÜ:
Tanim : :2014/33/AB Asansör Yönetmeliği Ek'Fin 3.2. maddesinde bahsi geçen ölçümleri Önlöyen yapı kabini ölçümleri veya kontrolüz hareketini engelleyen tertibatlar
: CPT Yöneli Kaldırma Gövencesi Tertibatı

Adı : ERKANLIFT
Markası : ERKANLIFT
Tipi : EL
Tipi Varyasyonları : EL-8
Temel Özellikler : Azami devreye girme hızı: 1,50 m/s, Azami kapasite: 4000 kg
Azami devreye girme hızı: 2,16 m/s, Azami kapasite: 3000 kg
Azami devreye girme hızı: 2,62 m/s, Azami kapasite: 2500 kg
Sertifika ekinde detaylandırılmıştır.

Bu sertifika ve ekinde belirlenen tip ve ekipman üzerinde gerçekleştirilecek değişiklikler veya ilgili standart üzerinde meydana gelebilecek değişiklik durumunda sertifikanın geçerliliği D KARE tarafından yeniden değerlendirilmelidir.
Bu sertifika 22/02/2022 tarihli ve LDsq08-0225-0115-22 numaralı final raporda belirlenen bulgular doğrultusunda düzenlenmiştir.
Gövencik ekipmanın uygulanışının değerlendirilmesi sırasında TS EN 81-20:2020 ve TS EN 81-50:2020 standartlarında belirlenen muayene ve deney metotları kullanılmıştır.

Selcan GÖRMÜŞ
Genel Müdür

Yayın Tarihi : 28 Şubat 2022
Geçerlilik Tarihi : 27 Şubat 2027

Genel Mah. Her Yönü St. Dröğes Park Plaza No:10 D:13 Mahallesi - 07100000
Tel: 032 260 18 76, Fax: 032 260 18 76, web: www.erkancan.com.tr, e-posta: info@erkancan.com.tr

AB TİP İNCELEME SERTİFİKASI
No: LDsq08-0228-0111-22

ERKAN ALÜMİNYUM ASANSÖR İNŞAAT DİŞ TİCARET SAN. VE TİC. LTD. ŞTİ.
Tatlıcaik Mah. Kıkırcılar Sok. No:38 - Karatay, Konya, Türkiye

D KARE GÖZETİM TEST VE BEĞELİRME T.C. LTD. ŞTİ. yalıında unvanı belirlen firması Ürettici ve yapıda teknik özellikler belirlenmiş olan asansör gövencesi akşamın, 2014/33/AB Asansör Yönetmeliğinin 1 numarası Ekinde belirlenen Temel Sağlık ve Güvenlik Kuralları karşılığında değerlendirilmiş olup, onaylanmıştır.

2014/33/AB Ek IV/A Asansör Gövencesi İçin AB Tip İncelemesi (Modül B) ÖRÜNÜ:
Tanim : :2014/33/AB Asansör Yönetmeliği Ek'Fin 3.2. maddesinde bahsi geçen ölçümleri Önlöyen yapı kabini ölçümleri veya kontrolüz hareketini engelleyen tertibatlar
: CPT Yöneli Kaldırma Gövencesi Tertibatı

Adı : ERKANLIFT
Markası : ERKANLIFT
Tipi : EL
Tipi Varyasyonları : EL-8
Temel Özellikler : Azami devreye girme hızı: 1,50 m/s, Azami kapasite: 2700 kg
Azami devreye girme hızı: 2,16 m/s, Azami kapasite: 2000 kg
Sertifika ekinde detaylandırılmıştır.

Bu sertifika ve ekinde belirlenen tip ve ekipman üzerinde gerçekleştirilecek değişiklikler veya ilgili standart üzerinde meydana gelebilecek değişiklik durumunda sertifikanın geçerliliği D KARE tarafından yeniden değerlendirilmelidir.
Bu sertifika 24/02/2022 tarihli ve LDsq08-0224-0113-22 numaralı final raporda belirlenen bulgular doğrultusunda düzenlenmiştir.
Gövencik ekipmanın uygulanışının değerlendirilmesi sırasında TS EN 81-20:2020 ve TS EN 81-50:2020 standartlarında belirlenen muayene ve deney metotları kullanılmıştır.

Selcan GÖRMÜŞ
Genel Müdür

Yayın Tarihi : 28 Şubat 2022
Geçerlilik Tarihi : 27 Şubat 2027

Genel Mah. Her Yönü St. Dröğes Park Plaza No:10 D:13 Mahallesi - 07100000
Tel: 032 260 18 76, Fax: 032 260 18 76, web: www.erkancan.com.tr, e-posta: info@erkancan.com.tr

AB TİP İNCELEME SERTİFİKASI
No: LDsq08-0228-0113-22

ERKAN ALÜMİNYUM ASANSÖR İNŞAAT DİŞ TİCARET SAN. VE TİC. LTD. ŞTİ.
Tatlıcaik Mah. Kıkırcılar Sok. No:38 - Karatay, Konya, Türkiye

D KARE GÖZETİM TEST VE BEĞELİRME T.C. LTD. ŞTİ. yalıında unvanı belirlen firması Ürettici ve yapıda teknik özellikler belirlenmiş olan asansör gövencesi akşamın, 2014/33/AB Asansör Yönetmeliğinin 1 numarası Ekinde belirlenen Temel Sağlık ve Güvenlik Kuralları karşılığında değerlendirilmiş olup, onaylanmıştır.

2014/33/AB Ek IV/A Asansör Gövencesi İçin AB Tip İncelemesi (Modül B) ÖRÜNÜ:
Tanim : :2014/33/AB Asansör Yönetmeliği Ek'Fin 3.2. maddesinde bahsi geçen ölçümleri Önlöyen yapı kabini ölçümleri veya kontrolüz hareketini engelleyen tertibatlar
: Yak Yöneli Kaldırma Gövencesi Tertibatı

Adı : ERKANLIFT
Markası : ERKANLIFT
Tipi : EL
Tipi Varyasyonları : EL-7, EL-8
Temel Özellikler : EL-7 (Azami devreye girme hızı: 1,50 m/s, Azami kapasite: 2400 kg, Azami devreye girme hızı: 2,16 m/s, Azami kapasite: 2000 kg)
EL-8 (Azami devreye girme hızı: 1,50 m/s, Azami kapasite: 2700 kg, Azami devreye girme hızı: 2,16 m/s, Azami kapasite: 2000 kg)
Sertifika ekinde detaylandırılmıştır.

Bu sertifika ve ekinde belirlenen tip ve ekipman üzerinde gerçekleştirilecek değişiklikler veya ilgili standart üzerinde meydana gelebilecek değişiklik durumunda sertifikanın geçerliliği D KARE tarafından yeniden değerlendirilmelidir.
Bu sertifika 24/02/2022 tarihli ve LDsq08-0224-0113-22 numaralı final raporda belirlenen bulgular doğrultusunda düzenlenmiştir.
Gövencik ekipmanın uygulanışının değerlendirilmesi sırasında TS EN 81-20:2020 ve TS EN 81-50:2020 standartlarında belirlenen muayene ve deney metotları kullanılmıştır.

Selcan GÖRMÜŞ
Genel Müdür

Yayın Tarihi : 28 Şubat 2022
Geçerlilik Tarihi : 27 Şubat 2027

Genel Mah. Her Yönü St. Dröğes Park Plaza No:10 D:13 Mahallesi - 07100000
Tel: 032 260 18 76, Fax: 032 260 18 76, web: www.erkancan.com.tr, e-posta: info@erkancan.com.tr

AB TİP İNCELEME SERTİFİKASI
No: LDsq08-0228-0114-22

ERKAN ALÜMİNYUM ASANSÖR İNŞAAT DİŞ TİCARET SAN. VE TİC. LTD. ŞTİ.
Tatlıcaik Mah. Kıkırcılar Sok. No:38 - Karatay, Konya, Türkiye

D KARE GÖZETİM TEST VE BEĞELİRME T.C. LTD. ŞTİ. yalıında unvanı belirlen firması Ürettici ve yapıda teknik özellikler belirlenmiş olan asansör gövencesi akşamın, 2014/33/AB Asansör Yönetmeliğinin 1 numarası Ekinde belirlenen Temel Sağlık ve Güvenlik Kuralları karşılığında değerlendirilmiş olup, onaylanmıştır.

2014/33/AB Ek IV/A Asansör Gövencesi İçin AB Tip İncelemesi (Modül B) ÖRÜNÜ:
Tanim : :2014/33/AB Asansör Yönetmeliği Ek'Fin 3.2. maddesinde bahsi geçen ölçümleri Önlöyen yapı kabini ölçümleri veya kontrolüz hareketini engelleyen tertibatlar
: Yak Yöneli Kaldırma Gövencesi Tertibatı

Adı : ERKANLIFT
Markası : ERKANLIFT
Tipi : EL
Tipi Varyasyonları : EL-7, EL-8
Temel Özellikler : EL-7 (Azami devreye girme hızı: 1,50 m/s, Azami kapasite: 2400 kg, Azami devreye girme hızı: 2,16 m/s, Azami kapasite: 2000 kg)
EL-8 (Azami devreye girme hızı: 1,50 m/s, Azami kapasite: 2700 kg, Azami devreye girme hızı: 2,16 m/s, Azami kapasite: 2000 kg)
Sertifika ekinde detaylandırılmıştır.

Bu sertifika ve ekinde belirlenen tip ve ekipman üzerinde gerçekleştirilecek değişiklikler veya ilgili standart üzerinde meydana gelebilecek değişiklik durumunda sertifikanın geçerliliği D KARE tarafından yeniden değerlendirilmelidir.
Bu sertifika 24/02/2022 tarihli ve LDsq08-0224-0114-22 numaralı final raporda belirlenen bulgular doğrultusunda düzenlenmiştir.
Gövencik ekipmanın uygulanışının değerlendirilmesi sırasında TS EN 81-20:2020 ve TS EN 81-50:2020 standartlarında belirlenen muayene ve deney metotları kullanılmıştır.

Selcan GÖRMÜŞ
Genel Müdür

Yayın Tarihi : 28 Şubat 2022
Geçerlilik Tarihi : 27 Şubat 2027

Genel Mah. Her Yönü St. Dröğes Park Plaza No:10 D:13 Mahallesi - 07100000
Tel: 032 260 18 76, Fax: 032 260 18 76, web: www.erkancan.com.tr, e-posta: info@erkancan.com.tr

INTERPRETATION OF TECHNOLOGY **TEKNOLOJİNİN YORUMU**

EX
P
R
A
S
E
N
T
E

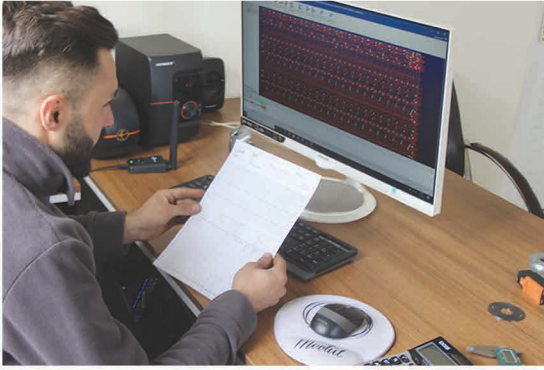



🏠 Tatlıcak Mh. Köksoylar Sk. No: 36 Karatay / KONYA / TÜRKİYE
☎️ +90 332 342 39 28 🖨️ +90 332 342 39 28
✉️ bilgi@erkanlift.com 🌐 www.erkanlift.com
📞 +90533 252 45 28 📱 +90 554 580 68 63

